



Schiedel Isokern Garden Fireplace Installation instructions

Model 1200
Build, rendering, firebricks and accessories

www.schiedel.com/uk



Cover photo by B. Halton-Farrow
Please note that the images show the version with the optional bottom log store.

Garden Fireplace 1200

Capping x 1

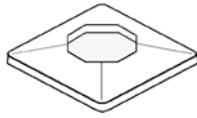

Chimney blocks x 3

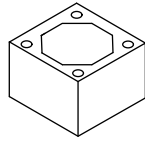

Top plate x 1

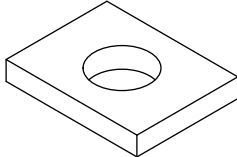

Gather front, back and sides x 4

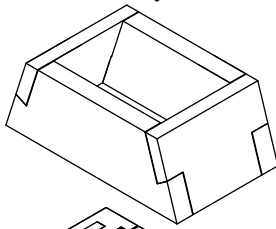

Sides and back x 3

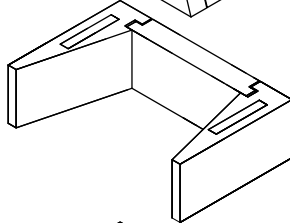

Sides and back x 3

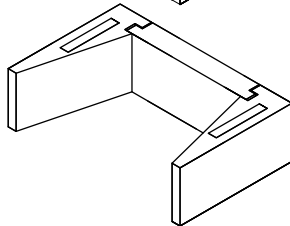

Sides and back x 3

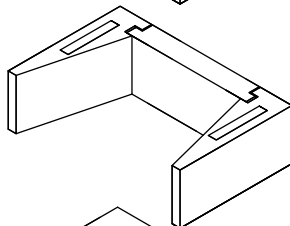

Base plate x 1

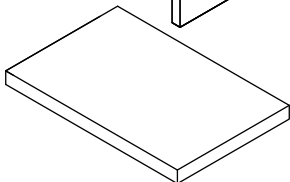

Log store component parts (supplied only if this option has been purchased)

2 sides, 1 back and 1 central block

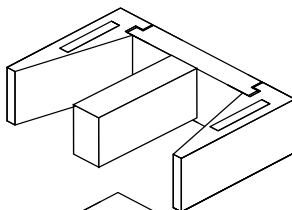

Base plate x 1

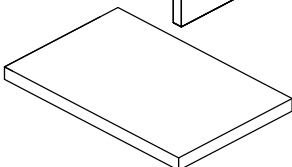

The Garden Fire 1200 comes complete with the following components:

- 2 bags of lip glue adhesive (for pumice components)
- 2 bags of render
- 1 log retainer kit (2 metal bars + 2 fixing brackets)
- 2 bags of Calderys fire brick mortar
- 1 set of pre-cut firebricks (see diagram below)

Fire brick diagram and parts for the 1200 model (see page 8 for more details)

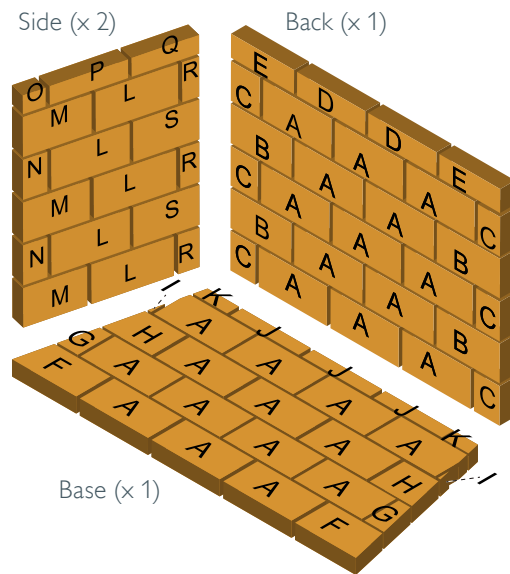

Log retainer kit (see page 10 for more details)

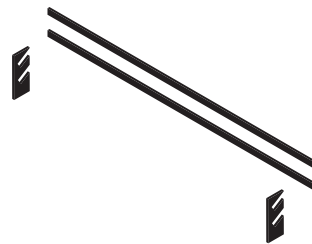

Preparation

The Garden Fire needs to be built onto a firm foundation. It should not be built directly onto decking. Schiedel recommends that a minimum 100mm reinforced concrete base is used to support the structure.

A distance of 75mm should be left between the Garden Fire and any wooden or other combustible material.

Instructions - Optional log store (If this has not been purchased, go to page 4)



Create a suitable base. We recommend 100mm thick reinforced concrete. Bed the base plate using the supplied adhesive or mortar mix. Check every stage is level.



Mix lip glue jointing adhesive as per instructions on the bag. Apply 15-20mm beads using the supplied application bag as shown in the picture above.



Press one side block into place and apply lip glue into the slot as shown.



Press back panel into place and then add the remaining side panel.



Press the middle section down on to the adhesive and apply additional adhesive as shown.



Press the base plate of the firechest down on to the log store. Keep checking all is level and remove any excess lip glue.

Installation Instructions - Firechest (Step 1)



Bed the base plate using the supplied lip glue onto the log store or a suitable 100mm thick reinforced concrete base. Check every stage is level.



Press one side block into place and apply the lip glue into the slot as shown.



Press back panel into place and the other side block.



Apply the lip glue adhesive on top of the first layer.



Add a further 2 layers of side blocks and back panels applying lip glue adhesive between each layer and at each joint. In total there are 3 layers on top of the base plate, as per the image. (If the log store option is not being used, then this base plate will be bedded directly on to a suitable prepared base.

Step 1 Base, sides and back complete

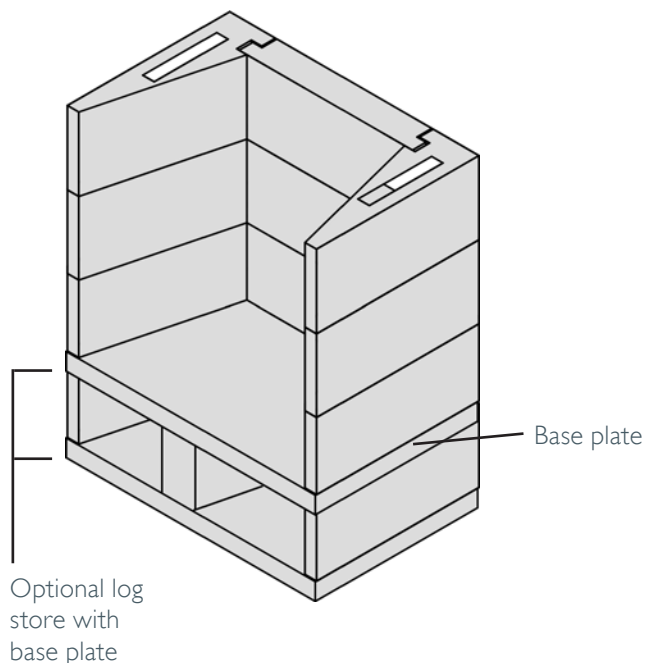

Instructions - Gather unit (Step 2)



Apply lip glue to the top layer and then press the front and rear sections of the gather into place.



Apply lip glue to the joints on the sides of the front and rear panels of the gather.



Press the side panels of the gather into place.



Apply lip glue to the top of the gather unit and then press the top plate into position with the hole offset closer to the rear section of the gather. Ensure the top section is level. Clean off any excess glue

Step 2 Gather Unit section complete

At this stage the Garden Fire should resemble the image with the gather unit above the three rows of the firechest area, a base plate with the log store beneath the base plate (if the log store option is being used)

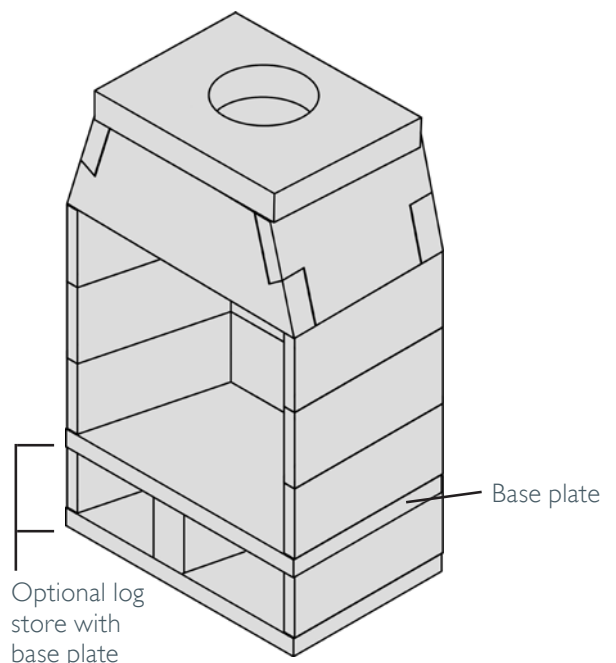

Instructions - Chimney blocks (Step 3)



Spread lip glue adhesive in the shape of the chimney block.



Press the first chimney block into place, checking it is in the correct position above the hole in the top plate.



Glue on the next two chimney blocks.



Glue on the capping.

Step 3 Blocks and capping complete

The fireplace is now complete with chimney blocks and capping. After the glue is touch dry, the rendering stage will commence.

This graphic shows a fireplace with the optional log store and base plate at the bottom.

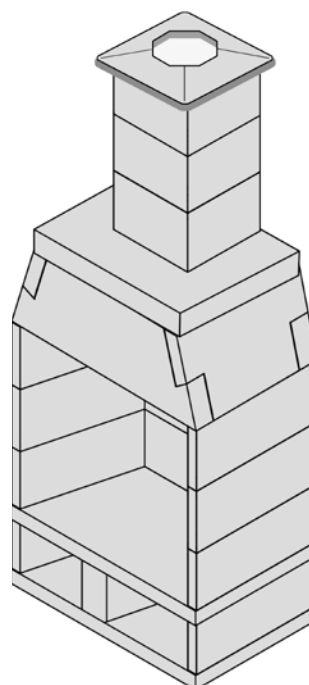

Instructions - Rendering (Step 4)



Render plaster

To be mixed, adhered to the surface and smoothed over by a competent person. As this is heat resistant plaster, it requires more care and pressure to spread than traditional plaster, which is much smoother.

Render plaster is designed for one coat, if you require more coats you will need to purchase more render.



Burn off the fibres on the external surface before rendering.



Mix the render as per the instructions on the bag.



Render the surface areas.



Ensure the edges are smooth and wait to dry.



The finished model, prior to adding firebricks and the log retainer.

Garden Fireplace firebricks guide

1200 model

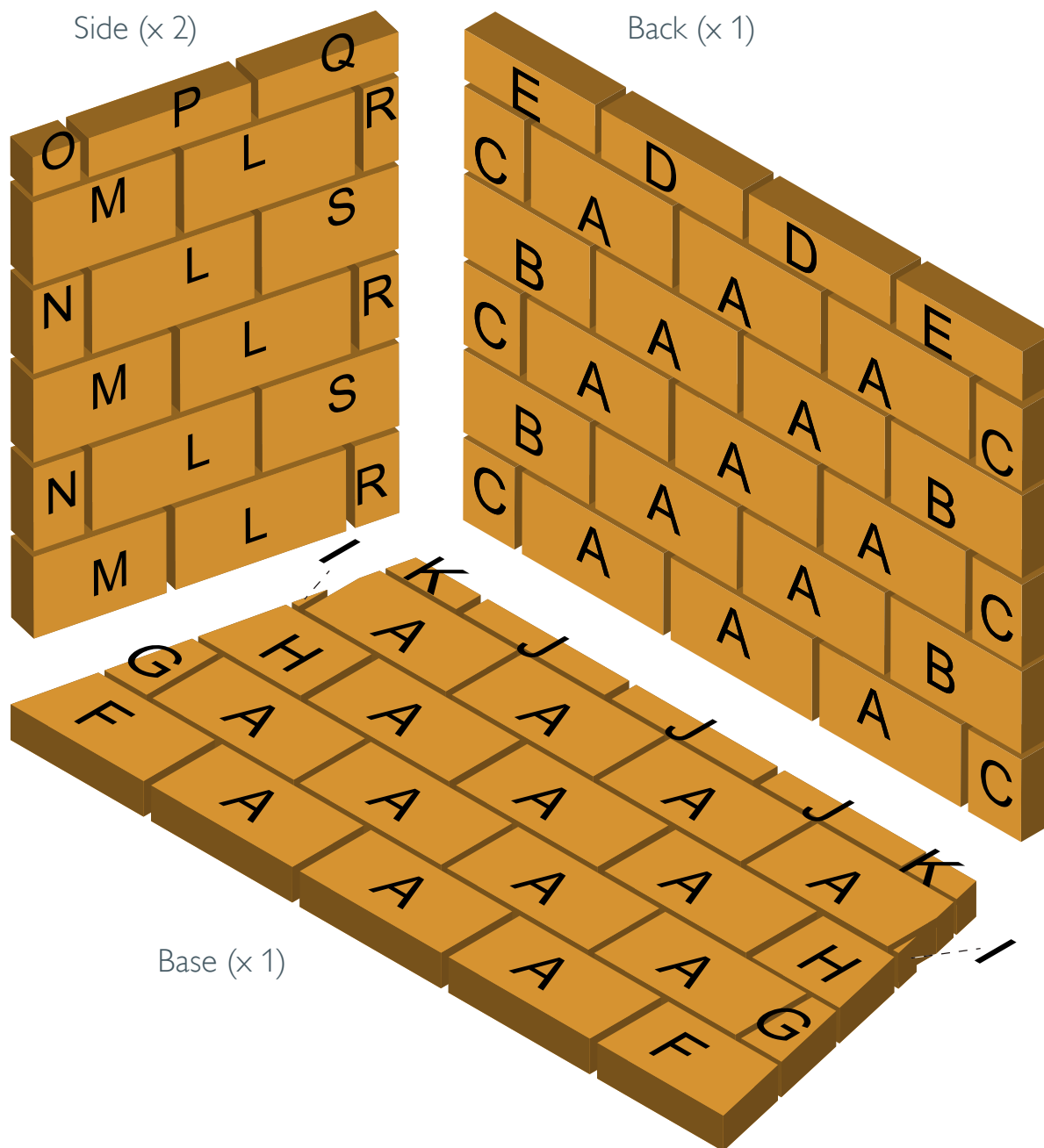

Brick	L	W	D	Brick	L	W	D	Brick	L	W	D
A	230	114	50	G	71	114	50	M	156	114	25
B	214	114	50	H	160	114	50	N	78	114	25
C	95	114	50	I	15	114	50	O	78	52	25
D	230	52	50	J	230	20	50	P	230	52	25
E	214	52	50	K	102	20	50	Q	156	52	25
F	220	114	50	L	230	114	25	R	78	114	25
								S	156	114	25

Sizes in mm

Note for all models

8mm gap between bricks.

Bedded on 1-3mm thick firebrick mortar

Firebricks to be glued on and pointed with the Calderys firebrick mortar as per enclosed instructions

Instructions - Firebricks (Step 5)



Mortar bag - Used for gluing on firebricks and pointing in. Mix as per instructions on the bag



Bed the firebricks on to a 3mm layer of firebrick mortar. Use the tables on the previous page as a guide.



Complete the bottom layer of firebricks, then fasten the rear firebricks in place using the firebrick mortar. Use a tile spacer to keep an 8mm gap.



Once the bottom and rear firebricks are in place, fasten the side bricks in position using the firebrick mortar. Use a tile spacer to keep an 8mm gap.



Use the mortar mix to point up the joints between the firebricks once they are all in position.



Clean off excess mortar.

Instructions - Log retainer (Step 6)



Drill 2 x 12mm diameter holes in the front row of the firebricks. Push log retainer holders in place.



Then push fit the log retainer bars into the slots.

Optional extras - rain cap and top ring (if purchased)



Rain cap and top ring if purchased.



Bend the steel prongs out so the top ring is a tight push fit into the concrete capping.



There are a range of optional accessories available for this Garden Fireplace. Please contact us or your distributor for more details and pricing.



Code	Optional extras
168902	Log storage for 1200
130708	Additional height blocks for 1200
135093	Top ring for 1200
130732	Rain cap for all models
130771	Lip glue 5kg
135329	Render plaster 25kg bag

After completion

Once build and rendering is complete, please do not use for at least 72 hours after completion.

On first use, always light a small fire first and increase the size of the fire once the firechest has fully dried out. Only use dried and seasoned wood for the fire. Do not burn plastic or waste products.

Guarantee

INTRODUCTION

We are confident in our products and so offer you (the owner) a generous guarantee in relation to the Garden Fireplace.

Provided that you comply in full with your responsibilities (below) and subject to the Small Print (below), we guarantee to you that the fireplace will be free from defects on delivery to you via pallet.

Any blocks or firebricks which are cracked or damaged at the time of delivery will be replaced free of charge.

This guarantee does not cover any major impact to the fireplace (such as wear and tear, wind damage) once the item has been constructed and rendered.

As the fireplace is an outdoor product, standard wear and tear will occur and any structural damage would have to be investigated. In the unlikely event that the fireplace becomes defective during the guarantee period, we will provide replacement component parts and render material free of charge.

YOUR RESPONSIBILITIES

To benefit from our guarantee, this product will be registered to the address where we delivered it. Please inform us if the fireplace was installed elsewhere.

HOW TO CLAIM UNDER YOUR GUARANTEE

To claim under your guarantee, please email us at sales.uk@schiedel.com. You will be asked to provide proof that you have complied in full with the terms of usage of the fireplace and that only dried and seasoned firewood has been used as a fuel.

If you are an installer / builder

If you are a regular builder of our Garden Fireplaces, then please get in touch with us. We are looking for competent builders throughout the UK and Republic of Ireland to promote as "recommended builders" in certain areas.

Builders are able to benefit from joining our Installer Loyalty scheme with points awarded for installations, which can then be redeemed for vouchers. Please see details at www.schiedelrewards.co.uk.

Also from Schiedel: The Celsius, an all-in-one stove and volcanic chimney package

The same material used in the Garden Fireplace; formed from pumice from the Hekla Volcano



Schiedel Isokern
Unit 8/9 Block A, Holton Road,
Holton Health Industrial Est., Poole
BH16 6LG
T +44 1202 861650

sales.uk@schiedel.com
www.schiedel.com/uk

The Celsius system is a DEFRA exempt, A+ rated system, which allows zero distance to combustibles.



The ideal stove and chimney combined package for any house development, log cabin, conservatory or outhouse.

Get in touch for more information.

Follow us on Social Media @SchiedelUK



A standard
INDUSTRIES COMPANY