



HIGH POSITIVE
PRESSURE

ICS 5000 Flue System

Multi-functional twin wall insulated venting system for use on heating appliances, stand-by gensets, CHP and service ducting.

SCHIEDEL

Product Description

ICS 5000 is a multi-functional twin wall insulated venting system, which is suitable for internal and external use on a wide range of engineering, combustion and process equipment, including heating appliances, diesel generators, CHP systems and service ducting.

ICS 5000 comes with a high quality specification as standard with a 316L Grade Stainless steel liner; high performance mineral blanket insulation and a bright annealed 304 Grade stainless steel outer case.

Both liner and outer case have a continuous seam welded joint and each flue gas bearing component has a uniquely profiled spigot and socket joint with bevelled end forms to ensure ease of installation whilst ensuring the joint meets H1 performance criteria at 5000 Pa.

The thermal insulation blanket ensures continuous insulation over the entire effective length of the liner; ensuring fast priming to normal operating temperatures, whilst maintaining low external surface temperatures.

Joint Design

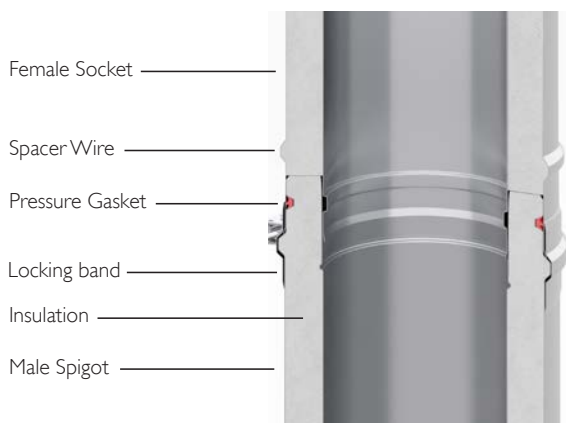

ICS 5000 Product Features

- Engineered spigot and socket joint
- Pronounced lead in edge
- Quick and easy assembly
- Pressure gasket on outer case protected by insulation
- Continuous insulation avoids thermal bridging
- Inner liner free to expand and contract
- No requirement for expansion joints
- Lightweight
- No onsite welding or cutting required

TECHNICAL DATA

ICS 5000	
Fuel	Diesel generators, gas, oil
Continuous Firing Temp	600° C
Mode of Operation	High Positive Pressure 5000 Pa (H1)
Outer Case	304 : 1.4301 : X5CrNi 18-10
Outer Case Thickness	0,5mm (Ø130-Ø300), 0,6mm (Ø350-Ø600), 0,7mm (Ø650-Ø700)
Seam	Fully seam welded
Inner Liner	316L : 1.4404 : X2CrNiMo 17-12-2
Inner Liner Thickness	0,5mm (Ø80 -350), 0,6mm (Ø400-Ø600)
Seam	Fully seam welded
Insulation	High performance mineral fibre
Insulation Thickness	25mm or 50mm
Average Thermal Resistance (200°C)	25mm 0.4 m ² k/W, 50mm 0.6 m ² k/W

CORROSION RESISTANCE

Chimneys are subject to significant corrosion attack by flue gas condensates, particularly from solid fuel and condensing appliances. ICS is specifically designed and manufactured to resist this corrosion. It is the only stainless steel chimney system in the world to have passed the internationally recognised Gastec corrosion test.

CHIMNEY DIAMETER

The chimney size should be as recommended by the appliance manufacturer. Where there is a requirement for a flue diameter smaller than the appliance spigot, then the operational requirements of the appliance and the configuration of the flue must satisfy the flue sizing requirements of BS EN 13384-1 for single appliances.

Approvals section

ICS 5000 is tested and approved in both 25mm and 50mm variants to BS EN 1856-1 as a System Chimney and to BS EN 1856-2 as a connecting flue pipe with the following designations

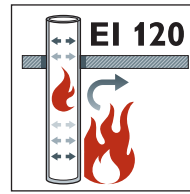

Schiedel is the first European chimney manufacturer to have performed the tests according to this latest fire resistance standard for chimneys.

System Chimney BS EN 1856-1 (TÜV 0036 CPR 9195 027)	
ICS25 5000	ICS50 5000
T600 H1 DV3 L50050 O75*	T600 H1 DV3 L50050 O25*
T200 H1 WV2 L50050 O50**	
*Distance to Combustibles	*Distance to Combustibles
*Ø80-Ø300 distance - 75mm	*Ø80-Ø300 distance - 25mm
*Ø350-Ø450 distance - 112.5mm	*Ø350-Ø450 distance - 37.5mm
*Ø500- Ø600 distance - 150mm	*Ø500- Ø600 distance - 50mm
**Ø80-Ø200 distance - 50mm	
Connecting Flue Pipe BS EN 1856-2 (TÜV 0036 CPR 9195 038)	
T600 H1 DV3 L50050 O100 M	
Connecting Flue Pipe BS EN 1856-2 (TÜV 0036 CPR 9195 036)	
T600 H1 DV3 L50050 O100 M	
EI 120 Fire rating to BS EN 1366-13 Chimneys	
ICS25 5000	ICS50 5000
Horizontal and Vertical	Horizontal and Vertical
BS 476 part 20 (4 Hour Fire Rating)	
ICS25 5000	ICS50 5000
Corrosion testing on Gas, Oil, Solid Fuel (TÜV 0036 CPR 9195 027)	
Gastec, MPA, TÜV	

Schiedel has recently successfully carried out fire resistance tests according to the latest European standard BS EN 1366-13:2019 "Fire resistance tests for service installations, Part 13: Chimneys" and has reached EI 120 classification for our Double Wall Insulated System Chimney ICS in a closed scenario (type A) for both vertical and horizontal set-ups.

For all the latest approval information and DOP's please refer to our website.

Starting components

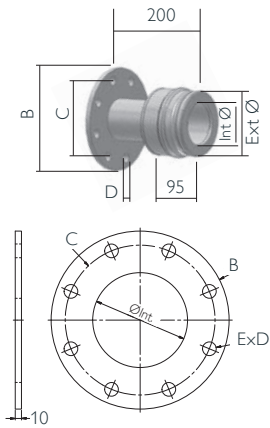

Male flanged adaptor & gasket with 10mm flange

Int Ømm	80	100	130	150	180	200	250	300	350	400	450	500	600
ICS25 Ext Ømm	130	150	180	200	230	250	300	350	400	450	500	550	650
ICS25 SAP code	110960	COA	112923	116875	114448	114462	114930	115656	115289	113781	113782	115587	115608
ICS50 Ext Ømm	180	200	230	250	280	300	350	400	450	500	550	600	700
ICS50 SAP Code	COA	COA	COA	COA	COA	COA	COA	COA	COA	COA	COA	COA	COA
B	200	220	250	285	315	340	395	445	505	565	615	670	780
C	160	180	210	240	270	295	350	400	460	515	565	620	725
D	18	18	18	22	22	22	22	22	22	22	26	30	30
E (Qty of D)	8	8	8	8	8	8	12	12	16	16	20	20	20

* B, C, D, E info applies to both ICS25 and ICS50 ranges

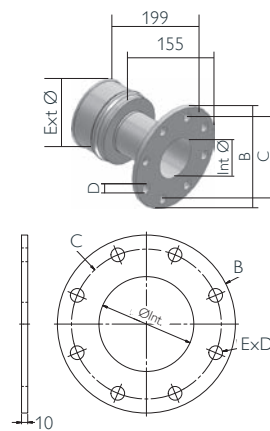

Female flanged adaptor with 10mm flange

Int Ømm	80	100	130	150	180	200	250	300	350	400	450	500	600
ICS25 Ext Ømm	130	150	180	200	230	250	300	350	400	450	500	550	650
ICS25 SAP code	114232	COA	116591	116810	117212	117519	117270	117739	118723	COA	COA	COA	COA
ICS50 Ext Ømm	180	200	230	250	280	300	350	400	450	500	550	600	700
ICS50 SAP Code	COA	COA	COA	COA	COA	COA	COA	COA	COA	COA	COA	COA	COA
B	200	220	250	285	315	340	395	445	505	565	615	670	780
C	160	180	210	240	270	295	350	400	460	515	565	620	725
D	18	18	18	22	22	22	22	22	22	22	26	30	30
E (Qty of D)	8	8	8	8	8	8	12	12	16	16	20	20	20

* B, C, D, E info applies to both ICS25 and ICS50 ranges

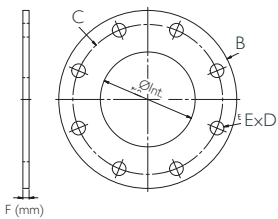

Non-standard flange (made to special order)

Int Ømm	80	100	130	150	180	200	250	300	350	400	450	500	600
ICS25 Ext Ømm	130	150	180	200	230	250	300	350	400	450	500	550	650
ICS50 Ext Ømm	180	200	230	250	280	300	350	400	450	500	550	600	700

Used in combination with the plain end adaptor below,
please provide us with the relevant information for B,C,D, and F dimensions as well as the quantity of E.

Plain end adaptor to ICS5000 with gasket

Int Ømm	80	100	130	150	180	200	250	300	350	400	450	500	600
ICS25 Ext Ømm	130	150	180	200	230	250	300	350	400	450	500	550	650
ICS25 SAP code	110415	110635	110858	112072	112879	112071	112761	113103	115414	116191	116595	116930	117403
ICS50 Ext Ømm	180	200	230	250	280	300	350	400	450	500	550	600	700
ICS50 SAP Code	111454	111942	112639	112939	113286	114186	114918	115181	115179	115983	115982	115981	117283

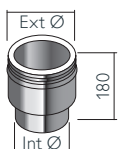

Silencers

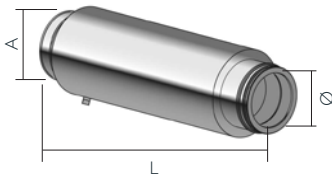

Absorption silencer with gasket - 25 dB													
Ø	100	130	150	180	200	250	300	350	400	450	500	600	
L	600	750	750	1000	1250	1250	175	1750	1750	2000	2000	2000	
A	225	255	275	305	325	375	425	475	525	575	625	725	
kg	9	10	11	15	20	24	49	55	60	79	86	100	
SAP Code	COA	COA	COA	COA	COA	COA	COA	COA	COA	COA	COA	COA	COA

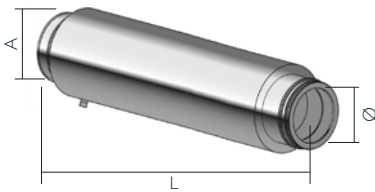

Absorption silencer with gasket - 35 dB													
Ø	100	130	150	180	200	250	300	350	400	450	500	600	
L	1000	1000	1000	1250	1500	1500	2500	2500	2500	3000	3000	3000	
A	225	255	275	325	325	375	425	475	525	575	625	725	
Kg	12	13	14	20	24	28	68	76	84	117	127	146	
SAP Code	COA	COA	COA	COA	COA	COA	COA	COA	COA	COA	COA	COA	COA

Average performance Absorption silencer Ø100-600

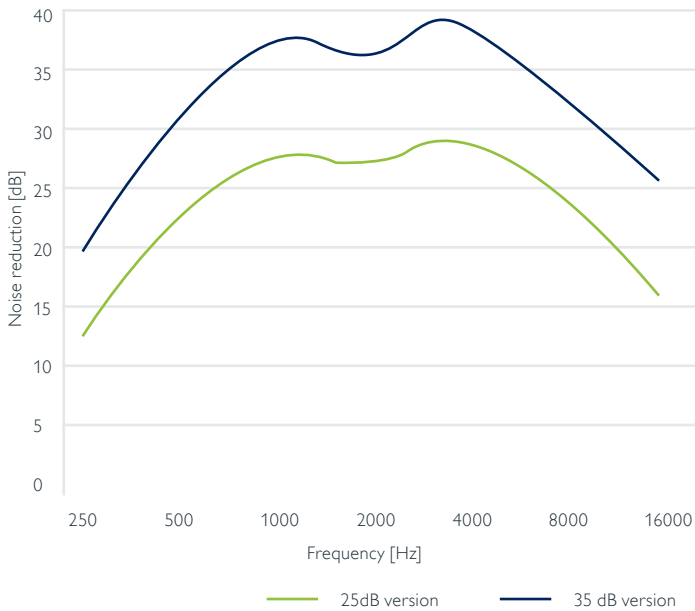

Performance chart is an average measurement over all diameters.
 The insertion loss is measured according to ISO 7235: 2003
 The insertion loss can deviate due to temperature or special installation situations.
 Back pressure is approx. 300 Pa at 15m/s or 2300 Pa at 50 m/s
 Back pressure can vary with temperature and gas velocity, please contact Schiedel Technical Dept for advice.

Pressure drop Absorption silencer Ø100-600

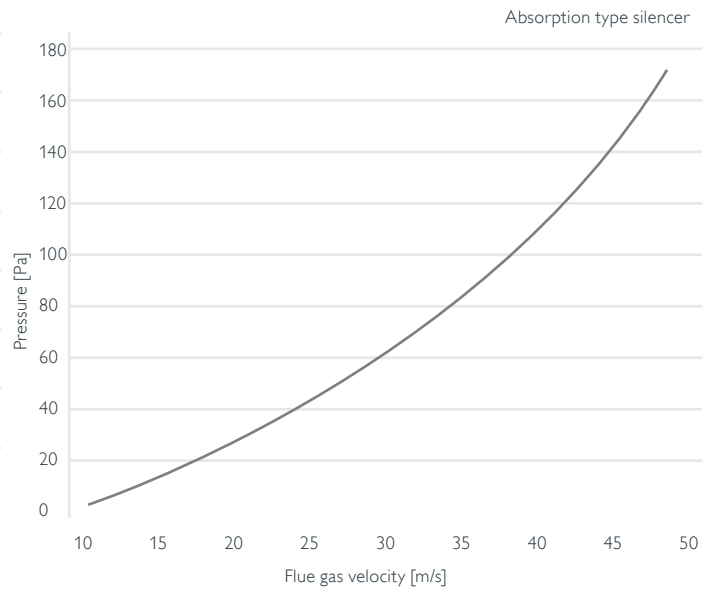

EXTRA OPTIONS
 Brackets (installation direction to be specified on order)
 Radial / axial inlet
 Radial / axial outlet
 (certified) spark arrester
 Flanged

STANDARD OPTIONS
 condensate drain
 lifting eyes

Silencers

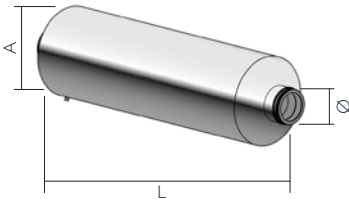

Resonance silencer with gasket - 20 dB												
Ø	100	130	150	180	200	250	300	350	400	450	500	600
L	2200	2200	2200	2200	2200	2200	2200	2200	2200	2200	2200	2200
A	400	450	500	600	650	700	850	950	1000	1100	1150	1350
kg	65	75	86	108	120	132	850	950	1000	1100	1150	1350
SAP Code	COA	COA	COA	COA	COA	COA	COA	COA	COA	COA	COA	COA
Lifting eyes standard for $\varnothing \geq 130$												

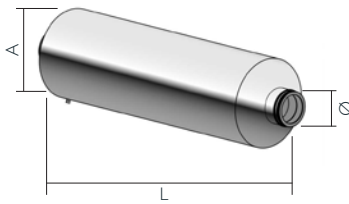

Resonance silencer with gasket - 30 dB												
Ø	100	130	150	180	200	250	300	350	400	450	500	600
L	2200	2200	2200	2200	2200	2400	2600	2800	3000	3200	3400	3600
A	550	650	750	800	850	1000	1000	1100	1200	1300	1350	1550
Kg	95	118	142	155	167	221	236	282	333	387	425	529
SAP Code	COA	COA	COA	COA	COA	COA	COA	COA	COA	COA	COA	COA
Lifting eyes standard for $\varnothing \geq 130$												

Average performance Resonance silencer Ø100-600

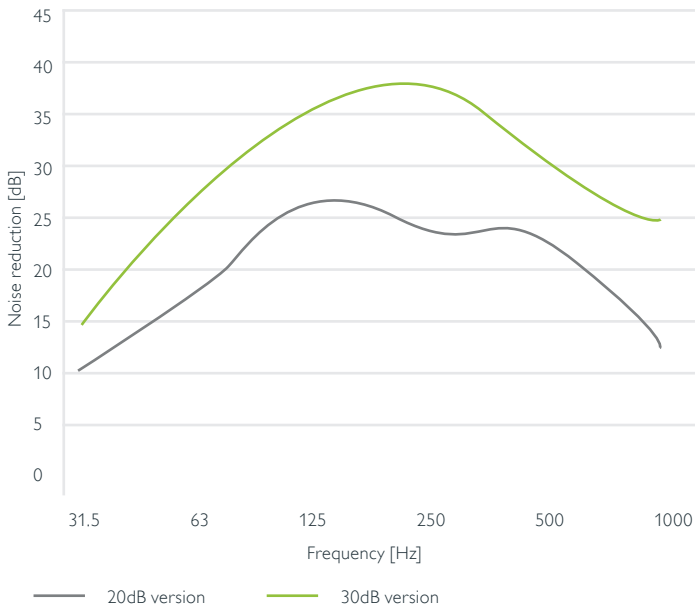

Performance chart is an average measurement over all diameters.
 The insertion loss is measured according to ISO 7235: 2003
 The insertion loss can deviate due to temperature or special installation situations.
 Back pressure is approx. 300 Pa at 15m/s or 2300 Pa at 50 m/s
 Back pressure can vary with temperature and gas velocity, please contact Schiedel
 Technical Dept for advice.

Pressure drop Resonance silencer Ø100-600

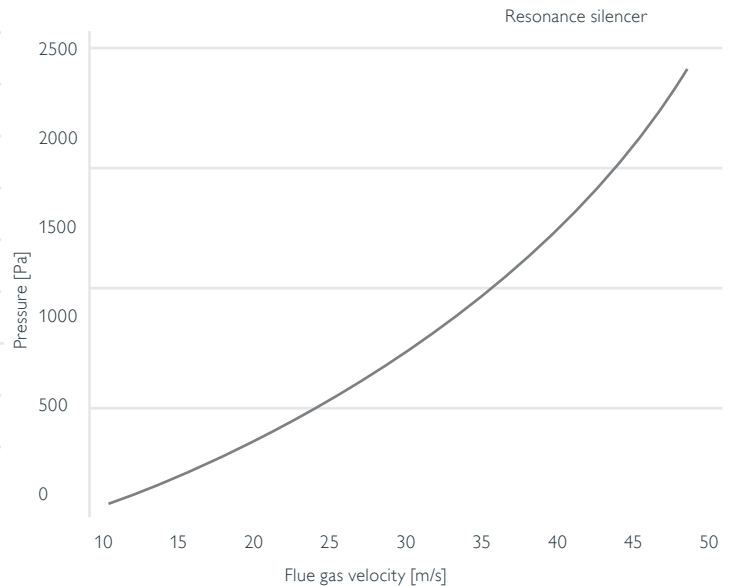

- | | |
|------------------------------------------------------------------------------------------------------------------------------------------------------------------------------------------------------------------------------------------------------------|-------------------------------------------------------------------------------------------------------------------------|
| <p>EXTRA OPTIONS</p> <ul style="list-style-type: none"> Brackets (installation direction to be specified on order) Radial / axial inlet Radial / axial outlet (certified) spark arrestor Flanged | <p>STANDARD OPTIONS</p> <ul style="list-style-type: none"> condensate drain lifting eyes |
|------------------------------------------------------------------------------------------------------------------------------------------------------------------------------------------------------------------------------------------------------------|-------------------------------------------------------------------------------------------------------------------------|

Pipes

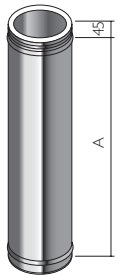

1000mm pipe + locking band & gasket

Int Ømm	80	100	130	150	180	200	250	300	350	400	450	500	600
ICS25 Ext Ømm	130	150	180	200	230	250	300	350	400	450	500	550	650
ICS25 SAP code	116491	117090	117581	117967	118307	118469	113602	113768	113898	114005	114020	113897	115589
A	955	955	955	955	955	955	955	955	955	955	955	955	955
Weight (kg)	3.99	4.73	5.84	6.58	7.69	8.43	10.28	12.08	13.96	15.81	19.10	21.10	25.09
ICS50 Ext Ømm	180	200	230	250	280	300	350	400	450	500	550	600	700
ICS50 SAP Code	118678	118679	118680	113650	118309	113802	113990	114102	115490	115544	115576	115612	116540
A	955	955	955	955	955	955	955	955	955	955	955	955	955
Weight (kg)	5.92	7.10	9.03	10.04	11.55	12.54	15.49	18.02	20.33	23.03	26.12	28.69	36.13

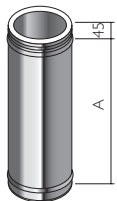

500mm pipe + locking band & gasket

Int Ømm	80	100	130	150	180	200	250	300	350	400	450	500	600
ICS25 Ext Ømm	130	150	180	200	230	250	300	350	400	450	500	550	650
ICS25 SAP code	113541	114696	115401	115908	116346	116726	117319	117692	118046	118366	118684	113620	113794
A	455	455	455	455	455	455	455	455	455	455	455	455	455
Weight (kg)	1.98	2.34	2.89	3.26	3.80	4.17	5.08	5.97	6.90	7.82	9.42	10.41	12.38
ICS50 Ext Ømm	180	200	230	250	280	300	350	400	450	500	550	600	700
ICS50 SAP Code	117079	117082	117083	117190	117084	117919	118343	118590	117078	118591	117077	113890	114100
A	455	455	455	455	455	455	455	455	455	455	455	455	455
Weight (kg)	2.96	3.55	4.49	4.94	6.17	6.50	7.64	8.89	10.06	11.90	13.24	15.30	17.82

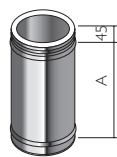

250mm pipe + locking band & gasket

Int Ømm	80	100	130	150	180	200	250	300	350	400	450	500	600
ICS25 Ext Ømm	130	150	180	200	230	250	300	350	400	450	500	550	650
ICS25 SAP code	111570	111979	112589	112905	113361	114261	114927	115439	116018	116372	117044	116023	117742
A	205	205	205	205	205	205	205	205	205	205	205	205	205
Weight (kg)	0.97	1.15	1.42	1.59	1.86	2.04	2.49	2.92	3.37	3.82	4.59	5.07	6.01
ICS50 Ext Ømm	180	200	230	250	280	300	350	400	450	500	550	600	700
ICS50 SAP Code	114759	114767	114766	114765	114764	115657	116283	116968	115669	115673	115660	118026	115662
A	205	205	205	205	205	205	205	205	205	205	205	205	205
Weight (kg)	1.48	1.78	2.15	2.40	2.76	3.00	3.67	4.30	4.88	6.09	6.77	7.44	9.01

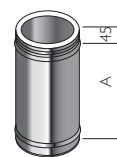

200mm pipe + locking band & gasket

Int Ømm	80	100	130	150	180	200	250	300	350	400	450	500	600
ICS25 Ext Ømm	130	150	180	200	230	250	300	350	400	450	500	550	650
ICS25 SAP code	111159	119253	111948	112246	112667	119252	113522	114602	115118	115680	117155	117371	117982
A	155	155	155	155	155	155	155	155	155	155	155	155	155
Weight (kg)	0.77	0.91	1.12	1.26	1.47	1.61	1.97	2.31	2.67	3.02	4.79	5.25	6.59
ICS50 Ext Ømm	180	200	230	250	280	300	350	400	450	500	550	600	700
ICS50 SAP Code	113455	113444	113452	113450	113453	115027	115025	115024	115020	118588	115018	115017	115015
A	155	155	155	155	155	155	155	155	155	155	155	155	155
Weight (kg)	1.18	1.42	1.92	2.16	2.45	2.65	3.13	3.63	4.12	4.49	4.97	5.45	6.41

Pipes

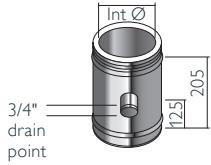

Vertical section with drain collection point + locking band & gasket

Int Ømm	80	100	130	150	180	200	250	300	350	400	450	500	600
ICS25 Ext Ømm	130	150	180	200	230	250	300	350	400	450	500	550	650
ICS25 SAP code	111710	112146	112139	112127	112144	112131	112141	115430	112140	112129	112136	112135	112132
Weight (kg)	1.03	1.22	1.49	1.68	1.95	2.14	2.60	3.05	3.52	3.98	4.69	5.17	6.12
ICS50 Ext Ømm	180	200	230	250	280	300	350	400	450	500	550	600	700
ICS50 SAP code	114649	114648	114647	114646	114645	114643	114650	114642	114641	114637	114639	114640	114638
Weight (kg)	1.66	1.96	2.33	2.62	2.98	3.21	3.80	4.41	5.00	5.45	6.97	8.12	9.77

Adj pipe (270mm to 375mm) + locking band & gaskets

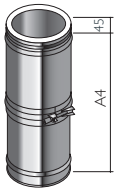

Int Ømm	80	100	130	150	180	200	250	300	350	400	450	500	600
ICS25 Ext Ømm	130	150	180	200	230	250	300	350	400	450	500	550	650
ICS25 SAP code	114407	114980	115769	114976	115448	115878	116482	117049	117401	118488	118692	113613	113788
Weight (kg)	2.15	2.54	3.13	3.51	4.10	4.49	5.47	6.42	7.42	8.44	9.41	10.38	12.32
ICS50 Ext Ømm	180	200	230	250	280	300	350	400	450	500	550	600	700
ICS50 SAP code	116919	116923	116922	117189	117512	117770	118184	118589	113584	113825	113933	114042	114167
Weight (kg)	2.92	3.55	4.43	4.89	5.59	6.06	7.39	8.96	10.15	12.93	14.36	16.51	19.45

Adj pipe (375mm to 585mm) + locking band & gaskets

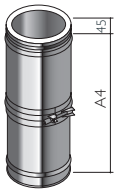

Int Ømm	80	100	130	150	180	200	250	300	350	400	450	500	600
ICS25 Ext Ømm	130	150	180	200	230	250	300	350	400	450	500	550	650
ICS25 SAP code	119255	119258	116883	117209	117555	117872	118304	118640	113622	119257	119256	119254	114084
Weight (kg)	3.02	3.57	4.40	4.94	5.77	6.31	7.69	9.03	10.43	11.87	13.23	14.60	17.32
ICS50 Ext Ømm	180	200	230	250	280	300	350	400	450	500	550	600	700
ICS50 SAP code	COA	COA	COA	126247	COA	127547	128461	128957	129315	COA	129710	COA	COA
Weight (kg)	-	-	-	7.37	-	9.2	11.22	19.9	14.98	-	19.09	-	-

Structural locking band

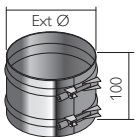

Int Ømm	80	100	130	150	180	200	250	300	350	400	450	500	600
ICS25 Ext Ømm	130	150	180	200	230	250	300	350	400	450	500	550	650
ICS25 SAP code	101124	101125	101126	101127	101128	101129	101131	101132	101133	101134	101135	101136	101138
ICS50 Ext Ømm	180	200	230	250	280	300	350	400	450	500	550	600	700
ICS50 SAP code	101126	101127	101128	101129	101130	101131	101132	101133	101134	101135	101136	101137	111716

Retrofit locking band gasket



Int Ømm	80	100	130	150	180	200	250	300	350	400	450	500	600
ICS25 Ext Ømm	130	150	180	200	230	250	300	350	400	450	500	550	650
ICS25 SAP code	COA	COA	COA	COA	COA	COA	COA	COA	COA	COA	COA	COA	COA
ICS50 Ext Ømm	180	200	230	250	280	300	350	400	450	500	550	600	700
ICS50 SAP code	COA	COA	COA	COA	COA	COA	COA	COA	COA	COA	COA	COA	COA

Bends

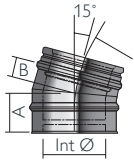

15° bend + locking band & gasket

Int Ømm	80	100	130	150	180	200	250	300
ICS25 Ext Ømm	130	150	180	200	230	250	300	350
ICS25 SAP code	111090	120567	111847	112166	112627	112853	113433	114522
A	55	55	55	55	60	60	65	65
B	96	95	95	95	100	100	105	105
Weight (kg)	0.74	0.88	1.08	1.22	1.43	1.57	1.91	2.25
ICS50 Ext Ømm	180	200	230	250	280	300	350	400
ICS50 SAP code	114294	114286	114296	114297	114298	114299	114300	116793
A	55	55	60	60	60	65	65	70
B	95	95	100	100	100	105	105	110
Weight (kg)	1.41	1.76	2.28	2.50	2.80	3.50	4.02	4.81

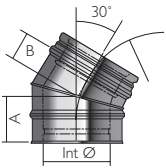

30° bend + locking band & gasket

Int Ømm	80	100	130	150	180	200	250	300	350	400	450	500	600
ICS25 Ext Ømm	130	150	180	200	230	250	300	350	400	450	500	550	650
ICS25 SAP code	119624	111400	119265	112176	113251	120568	114817	115348	116898	117262	118002	118232	118740
A	55	60	68	70	75	80	85	90	100	122	127	132	147
B	95	100	107	110	115	120	125	130	140	166	171	176	191
Weight (kg)	0.74	0.88	1.08	1.22	1.80	1.98	2.42	2.84	4.42	5.00	6.71	7.63	9.83
ICS50 Ext Ømm	180	200	230	250	280	300	350	400	450	500	550	600	700
ICS50 SAP code	114671	114672	114673	114674	114679	114675	114691	114676	114686	114678	114670	114680	114681
A	67	70	75	80	80	85	90	100	105	127	132	142	157
B	107	110	115	120	120	125	130	140	145	171	176	186	201
Weight (kg)	1.40	1.75	2.33	2.64	3.12	3.50	4.29	5.16	6.26	7.75	8.83	10.24	13.36

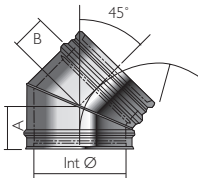

45° bend + locking band & gasket

Int Ømm	80	100	130	150	180	200	250	300	350	400	450	500	600
ICS25 Ext Ømm	130	150	180	200	230	250	300	350	400	450	500	550	650
ICS25 SAP code	111523	112804	112496	112810	113239	119267	115300	116375	116897	117275	118377	119263	113737
A	70	75	80	85	90	95	105	115	130	152	162	172	192
B	110	115	120	125	130	135	145	155	170	196	206	216	236
Weight (kg)	0.93	1.11	1.37	1.54	1.80	2.15	2.82	3.83	4.42	5.00	7.88	9.13	11.87
ICS50 Ext Ømm	180	200	230	250	280	300	350	400	450	500	550	600	700
ICS50 SAP code	115204	115206	115203	115210	115205	116598	116599	116600	116601	116605	116611	113801	113800
A	80	85	90	95	105	105	115	130	140	162	172	182	202
B	120	125	130	135	145	145	155	170	180	206	216	226	246
Weight (kg)	1.68	2.10	2.75	3.08	3.62	4.03	5.08	6.25	7.50	9.36	10.87	12.48	16.32

Bends

90° bend + locking band & gasket

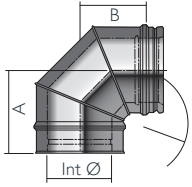

Int Ømm	80	100	130	150	180	200	250	300	350	400	450	500	600
ICS25 Ext Ømm	130	150	180	200	230	250	300	350	400	450	500	550	650
ICS25 SAP code	112215	112764	114218	114507	115270	115846	116848	117564	118132	118551	113823	113979	115484
A	128	136	152	161	176	188	212	237	264	290	396	421	471
B	172	180	196	205	220	232	256	281	308	330	434	459	509
Weight (kg)	1.20	1.50	2.00	2.38	3.07	3.39	4.55	5.84	7.33	9.80	11.61	13.60	18.00
ICS50 Ext Ømm	180	200	230	250	280	300	350	400	450	500	550	600	700
ICS50 SAP code	117441	117442	117454	117444	117449	113730	113728	113795	113797	114142	114141	115580	115578
A	152	161	176	188	204	212	237	264	290	396	421	446	497
B	196	205	220	232	248	256	281	308	330	434	459	484	535
Weight (kg)	2.00	2.40	3.28	3.90	5.03	5.56	7.46	9.58	12.02	16.94	19.05	22.31	29.52

Offsets (made by assembling 2 bends)

15° offset

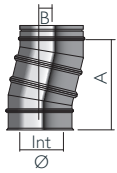

Int Ømm	80	100	130	150	180	200	250	300	350	400	450	500	300
ICS25 Ext Ømm	130	150	180	200	230	250	300	350	400	450	500	550	350
A	295	295	295	295	315	315	315	315	315	315	334	334	334
B	39	39	39	39	41	41	41	41	41	41	44	44	44
ICS50 Ext Ømm	180	200	230	250	280	300	350	400	450	500	550	600	400
A	295	295	315	315	315	315	315	315	334	334	334	334	354
B	39	39	41	41	41	41	41	41	44	44	44	44	47

30° offset

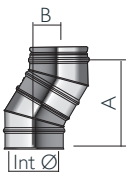

Int Ømm	80	100	130	150	180	200	250	300	350	400	450	500	600
ICS25 Ext Ømm	130	150	180	200	230	250	300	350	400	450	500	550	650
A	280	299	327	336	355	373	392	411	448	537	556	575	631
B	75	80	88	90	95	100	105	110	120	144	149	154	169
ICS50 Ext Ømm	180	200	230	250	280	300	350	400	450	500	550	600	700
A	327	336	355	373	373	392	411	448	467	556	575	612	668
B	88	90	95	100	100	105	110	120	125	149	154	164	179

45° offset

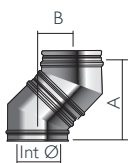

Int Ømm	80	100	130	150	180	200	250	300	350	400	450	500	600
ICS25 Ext Ømm	130	150	180	200	230	250	300	350	400	450	500	550	650
A	307	324	341	358	376	393	427	461	512	594	628	662	731
B	127	134	141	148	156	163	177	191	212	246	260	274	303
ICS50 Ext Ømm	180	200	230	250	280	300	350	400	450	500	550	600	700
A	341	358	376	393	427	427	461	512	546	628	662	696	765
B	141	148	156	163	177	177	191	212	226	260	274	288	317

Offsets (made by assembling 2 bends)

90° offset

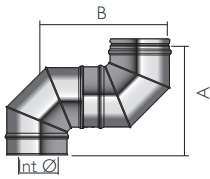

Int Ømm	80	100	130	150	180	200	250	300	350	400	450	500	600
ICS25 Ext Ømm	130	150	180	200	230	250	300	350	400	450	500	550	650
A	322	337	372	391	424	450	500	552	609	641	852	907	1013
B	295	309	341	359	388	412	458	506	558	588	781	831	928
ICS50 Ext Ømm	180	200	230	250	280	300	350	400	450	500	550	600	700
A	348	366	396	420	452	468	518	572	620	830	880	930	1032
B	348	366	396	420	452	468	518	572	620	830	880	930	1032

Offsets for 135° tee & 45° bend

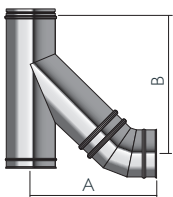

Int Ømm	80	100	130	150	180	200	250	300	350	400	450	500	600
ICS25 Ext Ømm	130	150	180	200	230	250	300	350	400	450	500	550	650
A	303	330	397	405	412	456	497	556	625	725	785	844	963
B	345	364	444	446	455	513	539	592	662	773	833	892	1016
ICS50 Ext Ømm	180	200	230	250	280	300	350	400	450	500	550	600	700
A	397	405	412	456	483	497	556	625	702	785	844	904	1023
B	444	446	455	513	515	539	592	662	762	833	892	957	1116

15° bend offset with standard pipe length

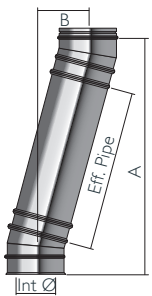

Int Ømm		80	100	130	150	180	200	250	300	350	400	450	500	600
ICS25 Ext Ømm			130	150	180	200	230	250	300	350	400	450	500	600
EFF Pipe	A		1218	1218	1238	1238	1238	1257	1257	1257	1277			
955	B		286	286	288	288	288	291	291	291	294			
EFF Pipe	A		735	735	755	755	755	774	774	774	794			
455	B		157	157	159	159	159	162	162	162	165			
EFF Pipe	A		493	493	513	513	513	532	532	532	552			
205	B		92	92	94	94	94	97	97	97	100			
EFF Pipe	A		445	445	465	465	465	484	484	484	504			
155	B		79	79	81	81	81	84	84	84	87			
ICS50 Ext Ømm			180	200	230	250	280	300	350	400				
EFF Pipe	A		1218	1218	1218	1218	1238	1238	1257	1257	1257			
955	B		286	286	286	286	288	288	291	291	291			
EFF Pipe	A		735	735	735	735	755	755	774	774	774			
455	B		157	157	157	157	159	159	162	162	162			
EFF Pipe	A		493	493	493	493	513	513	532	532	532			
205	B		92	92	92	92	94	94	97	97	97			
EFF Pipe	A		445	445	445	445	465	465	484	484	484			
155	B		79	79	79	79	81	81	84	84	84			

Typical offsets

(made by assembling 2 bends and a standard pipe section)

30° bend offset with standard pipe length

Int Ømm		80	100	130	150	180	200	250	300	350	400	450	500	600
ICS25 Ext Ømm		130	150	180	200	230	250	300	350	400	450	500	550	650
EFF Pipe	A	1107	1126	1154	1163	1182	1200	1219	1238	1275	1364	1383	1402	1458
	B	553	558	566	568	573	578	583	588	598	622	627	632	647
EFF Pipe	A	674	693	721	709	765	765	784	793	920	931	950	969	1025
455	B	303	308	316	318	323	328	333	338	348	372	377	382	397
EFF Pipe	A	458	477	505	514	533	551	570	589	626	715	734	753	809
205	B	178	183	191	193	198	203	208	213	223	247	252	257	272
EFF Pipe	A	414	433	461	470	489	507	526	545	582	671	690	709	765
155	B	153	158	166	168	173	178	183	188	198	222	227	232	247
ICS50 Ext Ømm		180	200	230	250	280	300	350	400	450	500	550	600	700
EFF Pipe	A	1154	1163	1182	1183	1202	1221	1239	1258	1295	1383	1402	1439	1495
955	B	566	568	573	574	579	584	589	594	604	627	632	642	657
EFF Pipe	A	721	730	749	767	767	786	805	842	861	950	969	1006	1062
455	B	316	318	323	328	328	333	338	348	353	377	382	392	407
EFF Pipe	A	505	514	533	551	551	570	589	626	645	734	753	790	846
205	B	191	193	198	203	203	208	213	223	228	252	257	267	282
EFF Pipe	A	461	470	489	507	507	526	545	582	601	690	709	746	802
155	B	166	168	173	178	178	183	188	198	203	227	232	242	257

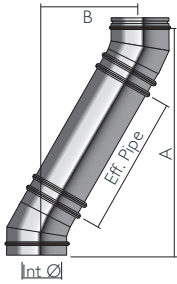

45° bend offset with standard pipe length

Int Ømm		80	100	130	150	180	200	250	300	350	400	450	500	600
ICS25 Ext Ømm		130	150	180	200	230	250	300	350	400	450	500	550	650
EFF Pipe	A	982	999	1016	1033	1051	1068	1102	1136	1187	1269	1303	1337	1406
955	B	802	809	816	823	831	838	852	866	887	921	935	949	978
EFF Pipe	A	629	646	663	680	698	715	749	783	834	916	950	984	1053
455	B	449	456	463	470	478	485	499	513	534	568	582	596	625
EFF Pipe	A	452	469	486	503	521	538	572	606	657	739	773	807	876
205	B	272	279	286	293	301	308	322	336	357	391	405	419	448
EFF Pipe	A	417	434	451	468	486	503	537	571	622	704	738	772	841
155	B	237	244	251	258	266	273	287	301	322	356	370	384	413
ICS50 Ext Ømm		180	200	230	250	280	300	350	400	450	500	550	600	700
EFF Pipe	A	1016	1033	1051	1068	1102	1102	1136	1187	1221	1303	1337	1371	1440
955	B	816	823	831	838	852	852	866	887	901	935	949	963	992
EFF Pipe	A	663	680	698	715	749	749	783	834	868	950	984	1018	1087
455	B	463	470	478	485	499	499	513	534	548	582	596	610	639
EFF Pipe	A	486	503	521	538	572	572	606	657	691	773	807	841	910
205	B	286	293	301	308	322	322	336	357	371	405	419	433	462
EFF Pipe	A	451	468	486	503	537	537	571	622	656	738	772	806	875
155	B	251	258	266	273	287	287	301	322	336	370	384	398	427

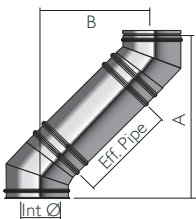

Typical offsets

(made by assembling 2 bends and a standard pipe section)

90° bend offset with standard pipe length

Int Ømm		80	100	130	150	180	200	250	300	350	400	450	500	600
ICS25 Ext Ømm		130	150	180	200	230	250	300	350	400	450	500	550	650
EFF Pipe	A	300	316	348	366	396	420	468	518	572	620	830	880	980
955	B	1255	1271	1303	1321	1351	1375	1423	1473	1527	1575	1785	1835	1935
EFF Pipe	A	300	316	348	366	396	420	468	518	572	620	830	880	980
455	B	755	771	803	821	851	875	923	973	1027	1075	1285	1335	1435
EFF Pipe	A	300	316	348	366	396	420	468	518	572	620	830	880	980
205	B	505	521	553	571	601	625	673	723	777	825	1035	1085	1185
EFF Pipe	A	300	316	348	366	396	420	468	518	572	620	830	880	980
155	B	455	471	503	521	551	575	623	673	727	775	985	1035	1135
ICS50 Ext Ømm		180	200	230	250	280	300	350	400	450	500	550	600	700
EFF Pipe	A	348	366	396	420	452	468	518	572	620	830	880	930	1032
955	B	1303	1321	1351	1375	1407	1423	1473	1527	1575	1785	1835	1885	1987
EFF Pipe	A	348	366	396	420	452	468	518	572	620	830	880	930	1032
455	B	803	821	851	875	907	923	973	1027	1075	1285	1335	1385	1487
EFF Pipe	A	348	366	396	420	452	468	518	572	620	830	880	930	1032
205	B	553	571	601	625	657	673	723	777	825	1035	1085	1135	1237
EFF Pipe	A	348	366	396	420	452	468	518	572	620	830	880	930	1032
155	B	503	521	551	575	607	623	673	727	775	985	1035	1085	1187

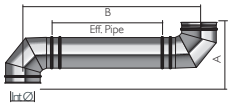

Tees

90° tee + locking bands and gasket

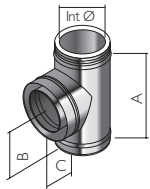

Int Ømm	80	100	130	150	180	200	250	300	350	400	450	500	600
ICS25 Ext Ømm	130	150	180	200	230	250	300	350	400	450	500	550	650
ICS25 SAP code	120563	120564	116097	116451	117026	117293	117947	118372	113617	113616	119261	114129	114132
A	288	288	455	455	455	455	455	480	530	605	655	705	805
B	126	126	209	209	209	209	209	222	247	285	310	335	385
C	105	115	130	140	155	165	190	205	240	280	305	330	380
Weight (kg)	1.63	1.95	3.42	3.88	4.57	5.04	6.56	7.9	10.39	13.36	15.51	18.7	23.5
ICS50 Ext Ømm	180	200	230	250	280	300	350	400	450	500	550	600	700
ICS50 SAP code	117843	117157	117847	118542	118548	118546	113595	113883	113887	113886	113884	113885	118073
A	455	455	455	455	455	455	480	530	605	655	705	755	855
B	209	209	209	209	209	209	222	247	285	310	335	360	410
C	130	140	155	165	180	190	205	240	280	305	330	355	405
Weight (kg)	3.85	4.81	6.23	7	7.97	8.62	10.22	13.61	16.79	32.26	38.48	45.23	60.3

135° tee + locking bands and gasket

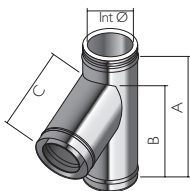

Int Ømm	80	100	130	150	180	200	250	300	350	400	450	500	600
ICS25 Ext Ømm	130	150	180	200	230	250	300	350	400	450	500	550	650
ICS25 SAP code	113315	114935	116670	117054	117410	118016	118530	113725	113956	114114	115524	115600	116544
A	330	355	455	455	455	530	560	623	697	815	885	955	1100
B	218	246	328	329	322	378	413	472	530	615	675	735	855
C	219	245	328	328	325	376	410	469	530	615	675	735	855
ICS50 Ext Ømm	180	200	230	250	280	300	350	400	450	500	550	600	700
ICS50 SAP code	119283	119285	119284	118533	113638	113732	114006	115501	115591	117234	117701	118072	118625
A	328	328	325	376	390	410	469	530	615	675	735	795	915
B	455	455	455	530	530	560	623	697	815	885	955	1030	1210
C	328	329	322	378	393	413	472	530	615	675	735	795	915

Inspection tee + locking bands and gasket

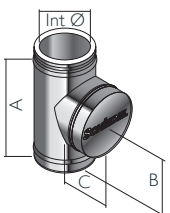

Int Ømm	80	100	130	150	180	200	250	300	350	400	450	500	600
ICS25 Ext Ømm	130	150	180	200	230	250	300	350	400	450	500	550	650
ICS25 SAP code	114212	114578	113216	115004	115713	116313	117460	118020	118364	118365	118361	114130	114131
A	288	288	455	455	455	455	455	480	530	605	655	705	805
B	126	126	209	209	209	209	209	222	247	285	310	335	385
C	200	210	225	235	250	260	285	300	335	375	400	425	475
Weight (kg)	1.97	2.27	1.76	3.29	3.68	4.71	6.88	7.73	9.16	11.3	12.36	13.40	15.48
ICS50 Ext Ømm	180	200	230	250	280	300	350	400	450	500	550	600	700
ICS50 SAP code	119281	117577	119282	117487	117494	117492	117491	117490	120570	117496	117498	117236	117237
A	455	455	455	455	455	455	480	530	605	655	705	755	855
B	209	209	209	209	209	209	222	247	285	310	335	360	410
C	235	245	250	260	275	285	300	335	375	400	425	450	500
W1	90	90	90	90	90	90	90	90	90	90	90	90	90
Weight (kg)	4.85	5.81	7.40	8.32	9.55	10.39	12.48	16.43	20.21	36.35	43.29	50.81	67.59

Tees

Tee plug & gasket

Int Ømm	80	100	130	150	180	200	250	300	350	400	450	500	600
ICS25 Ext Ømm	130	150	180	200	230	250	300	350	400	450	500	550	650
ICS25 SAP code	111682	112462	113051	113485	114631	115034	116010	116633	117068	117324	117367	117510	117934
A	95	95	95	95	95	95	95	95	95	95	95	95	95
Weight (kg)	1.01	1.3	1.7	1.9	2.3	2.6	3.4	4.1	4.7	5.1	5.2	5.6	6.5
ICS50 Ext Ømm	180	200	230	250	280	300	350	400	450	500	550	600	700
ICS50 SAP code	112004	112019	112025	112018	112017	112006	114536	114535	114532	114531	114539	117508	114534
A	95	95	95	95	95	95	95	95	95	95	95	95	95
Weight (kg)	1.17	1.17	1.17	1.17	1.17	1.17	2.27	2.27	2.27	2.27	2.27	5.58	2.27

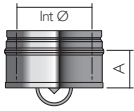

Tee plug with drain & gasket

Int Ømm	80	100	130	150	180	200	250	300	350	400	450	500	600
ICS25 Ext Ømm	130	150	180	200	230	250	300	350	400	450	500	550	650
ICS25 SAP code	111681	112540	113056	113490	114626	115037	116016	116631	117067	117320	117365	117511	113811
A	95	95	95	95	95	95	95	95	95	95	95	95	95
Weight (kg)	1.0	33.60	40.80	54.32	55.92	72.80	94.08	102.25	112.80	142.24	124.80	133.92	289.34
ICS50 Ext Ømm	180	200	230	250	280	300	350	400	450	500	550	600	700
ICS50 SAP code	112022	112021	112020	112424	112875	113174	114540	115307	116119	116628	117156	117505	118170
A	95	95	95	95	95	95	95	95	95	95	95	95	95
Weight (kg)	1.17	1.17	1.17	1.32	1.58	1.77	2.27	2.82	3.43	4.09	4.81	5.58	7.29

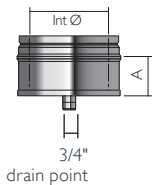

Support components

Top Plate + locking band and gasket

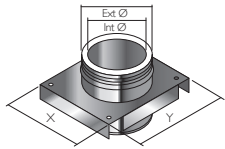

Int Ømm	80	100	130	150	180	200	250	300	350	400	450	500	600
ICS25 Ext Ømm	130	150	180	200	230	250	300	350	400	450	500	550	650
ICS25 SAP code	113104	115159	115144	115158	115765	116059	116683	117198	117798	118177	118495	118717	113772
A	95	95	95	95	95	95	95	95	95	92	92	92	92
X	188	208	238	258	278	315	335	385	435	485	535	585	685
Y	255	275	305	325	355	383	403	453	503	553	603	653	753
Weight (kg)	1.65	2.07	2.69	3.11	3.73	4.15	5.19	6.22	7.26	8.07	9.08	10.09	12.10
ICS50 Ext Ømm	180	200	230	250	280	300	350	400	450	500	550	600	700
ICS50 SAP code	117214	116239	117059	117215	117538	117825	118208	118587	113621	119289	119288	119287	121052
A	95	95	95	95	95	95	95	95	95	92	92	92	92
X	238	258	278	285	315	335	385	435	485	535	585	635	735
Y	305	325	355	353	383	403	453	503	553	603	653	703	803
Weight (kg)	2.91	3.62	4.67	4.96	5.68	6.18	7.55	8.96	10.42	11.83	13.30	15.18	18.84

Cantilever support

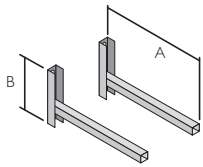

Wall fixing hole size
13mm dia

Type	325	475
A	325	475
B	242	242
Weight (kg)	1.24	1.54
ICS25 Int Ømm	80 - 150	80-300
ICS25 Ext Ømm	130 -200	130 - 350
ICS25 SAP code	101742	101743
ICS50 Int Ømm	80 - 100	80 - 250
ICS50 Ext Ømm	180 - 200	180 -350
ICS50 SAP Code	101742	101743

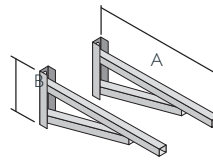

Wall fixing hole size
13mm dia

Cantilever support

Type	570	720	820
A	570	720	820
B	330	330	380
Weight (kg)	2.23	2.46	2.76
ICS25 Int Ømm	80 - 500	80-600	80-600
ICS25 Ext Ømm	130 - 550	130 - 650	130 - 650
ICS25 SAP code	101744	101746	101747
ICS50 Int Ømm	80 - 450	80 - 500	80 - 600
ICS50 Ext Ømm	180 - 550	180 - 600	180 - 700
ICS50 SAP Code	101744	101746	101747

Wall support side plates

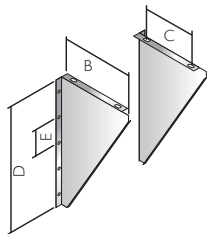

Wall fixing hole size
10mm dia

Int Ømm	80	100	130	150	180	200	250	300	350	400	450	500	600
ICS25 Ext Ømm	130	150	180	200	230	250	300	350	400	450	500	550	650
ICS25 SAP code	101042	101043	101044	101045	101046	101047	101048	101049	101050	101051	101052	101053	101054
A	220	240	270	290	310	315	365	415	465	515	565	615	715
B	470	470	470	470	470	470	470	470	670	670	670	870	870
C	100	100	100	100	100	100	100	100	100	100	100	100	100
X	35	35	35	35	35	35	35	35	35	35	35	35	35
Y	28	28	28	28	28	28	28	28	28	28	28	28	28
Weight (kg)	2.2	2.39	2.85	3.14	3.32	3.54	3.72	4	5.4	7.58	8.2	11.2	19.14
ICS50 Ext Ømm	180	200	230	250	280	300	350	400	450	500	550	600	700
ICS50 SAP code	101044	101045	101046	101047	101339	101048	101049	101050	101051	101052	101053	104395	104396
A	270	290	310	315	345	365	415	465	515	565	615	665	765
B	470	470	470	470	470	470	470	670	670	670	870	870	870
C	100	100	100	100	100	100	100	100	100	100	100	100	100
X	35	35	35	35	35	35	35	35	35	35	35	35	35
Y	28	28	28	28	28	28	28	28	28	28	28	28	28
Weight (kg)	2.85	3.14	3.32	3.54	3.61	3.72	4	5.4	7.58	8.2	11.2	15.36	20.06

Support components

Top plate with drain & gasket

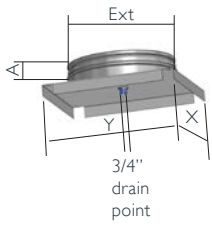

Int Ømm	80	100	130	150	180	200	250	300	350	400	450	500	600
ICS25 Ext Ømm	130	150	180	200	230	250	300	350	400	450	500	550	650
ICS25 SAP code	113033	113034	114426	116251	116864	117173	117856	118349	118671	117955	113676	113812	114033
A	94	94	94	94	94	94	94	94	94	100	100	100	100
X	238	208	238	258	278	285	335	385	435	485	535	585	685
Y	305	275	305	325	355	353	403	453	503	553	603	653	753
ICS50 Ext Ømm	180	200	230	250	280	300	350	400	450	500	550	600	700
ICS50 SAP code	119290	119298	119297	114596	119296	114586	115995	119295	119294	119293	119292	120569	119291
A	94	94	94	94	94	94	94	94	94	100	100	100	100
X	238	258	278	285	315	335	385	435	485	535	585	635	735
Y	305	325	355	353	383	403	453	503	553	603	653	703	803

Base support with drain & gasket

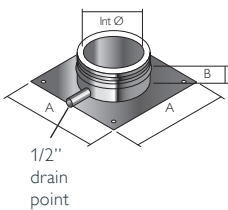

Int Ømm	80	100	130	150	180	200	250	300	350	400	450	500	600
ICS25 Ext Ømm	130	150	180	200	230	250	300	350	400	450	500	550	650
ICS25 SAP code	148369	113140	115833	116252	116865	117174	117853	118350	118674	101323	101324	113876	114083
A	200	200	250	250	250	333	350	400	450	550	600	650	750
B	135	135	135	135	135	135	135	135	135	110	110	110	110
Weight (kg)	1.3	1.7	3.2	3.6	4.4	4.9	6.3	7.8	9.4	10.6	11.9	13.5	17.2
ICS50 Ext Ømm	180	200	230	250	280	300	350	400	450	500	550	600	700
ICS50 SAP code	148370	148371	148372	115998	115993	116001	116002	116003	116004	116000	116005	115997	115996
A	250	250	250	333	333	350	400	450	500	550	600	650	750
B	135	135	135	135	135	135	135	135	135	135	135	135	135
Weight (kg)	2.07	2.23	2.48	3.35	3.35	3.35	3.35	3.35	3.35	3.35	3.35	3.35	3.35

Structural wall band (50mm)

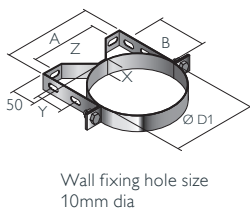

Int Ømm	80	100	130	150	180	200	250	300	350	400	450	500	600
ICS25 Ext Ømm	130	150	180	200	230	250	300	350	400	450	500	550	650
ICS25 SAP code	101263	101264	101265	101266	101267	101268	101269	101270	101271	101272	101273	101274	101275
A	138	158	188	208	238	258	308	358	412	462	512	562	662
B	115.6	125.6	140.6	150.6	165.6	175.6	200.6	225.2	250.2	275.2	300.3	325.3	375.3
D1	131.1	151.2	181.1	201.1	231.1	251.1	301.1	350.4	400.4	450.4	500.5	550.5	650.5
X	36	36	36	36	36	36	36	60	60	60	60	60	60
Y	55	55	55	55	55	55	85	125	145	145	145	145	145
Z	100	120	150	170	200	220	270	320	370	420	470	520	620
Weight (kg)	0.44	0.48	0.53	0.58	0.64	0.70	0.79	0.85	1.33	1.60	2.09	3.20	4.00
ICS50 Ext Ømm	180	200	230	250	280	300	350	400	450	500	550	600	700
ICS50 SAP code	101265	101266	101267	101268	101402	101269	101270	101271	101272	101273	101274	133782	104430
A	188	208	238	258	288	308	358	412	462	512	562	612	712
B	140.6	150.6	165.6	175.6	190.6	200.6	225.2	250.2	275.2	300.3	325.3	350	400
D1	181.1	201.1	231.1	251.1	281.1	301.1	350.4	400.4	450.4	500.5	550.5	600.5	701
X	36	36	36	36	36	36	60	60	60	60	60	60	60
Y	55	55	55	55	85	85	125	145	145	145	145	145	145
Z	150	170	200	220	250	270	320	370	420	470	520	570	670
Weight (kg)	0.53	0.58	0.64	0.7	0.64	0.79	0.85	1.33	1.6	1.96	2.09	6.3	5.5

Support components

Type W1

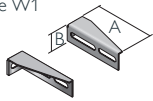

Wall fixing hole size
13mm dia

Structural wall band ext	
Type	W1
Adjustment	55-100
ICS SAP Code	101735
A	130
B	36
Weight (kg)	0.13

Types L1, L2

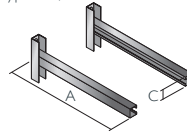

Wall fixing hole size
13mm dia

Structural wall band ext		
Type	L1	L2
Adjustment	100-250	100-440
ICS SAP Code	143846	143847
A	300	450
B	150	150
C	32	32
Weight (kg)	0.75	0.95

Roof support

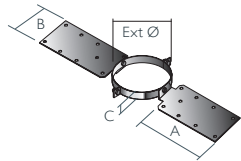

Int Ømm	80	100	130	150	180	200	250	300
ICS25 Ext Ømm	130	150	180	200	230	250	300	350
ICS25 SAP code	100960	100961	100962	100963	100964	100965	100967	129146
A	330	330	330	330	330	330	330	330
B	80	80	80	80	80	80	80	80
C	60	60	60	60	60	60	60	60
Weight (kg)	1.00	1.10	1.22	1.25	1.30	1.33	1.37	1.40
ICS50 Ext Ømm	180	200	230	250	280	300	350	-
ICS50 SAP code	100962	100963	100964	100965	100966	100967	129146	-
A	330	330	330	330	330	330	330	-
B	80	80	80	80	80	80	80	-
C	60	60	60	60	60	60	60	-
Weight (kg)	1.22	1.25	1.30	1.33	1.33	1.37	1.40	-

Guy wire bracket

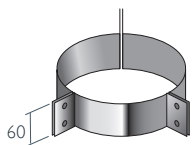

Int Ømm	80	100	130	150	180	200	250	300	350	400	450	500	600
ICS25 Ext Ømm	130	150	180	200	230	250	300	350	400	450	500	550	650
ICS25 SAP code	100639	100640	100641	100642	100643	100644	100646	129134	129409	129593	129793	129942	130167
Weight (kg)	0.44	0.47	0.50	0.54	0.58	0.61	0.68	0.49	0.50	0.50	0.60	0.70	0.90
ICS50 Ext Ømm	180	200	230	250	280	300	350	400	450	500	550	600	700
ICS50 SAP code	100641	100642	100643	100644	100645	100646	129134	129409	129593	129793	129942	100652	100654
Weight (kg)	0.50	0.54	0.58	0.61	0.58	0.68	0.49	0.50	0.50	0.60	0.70	0.80	2.39

EI 120 firestop plates

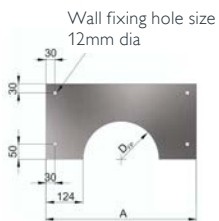

Wall fixing hole size
12mm dia

Int Ømm	80	100	130	150	180	200	250	300	350	400	450	500	600
ICS25 Ext Ømm	130	150	180	200	230	250	300	350	400	450	500	550	650
ICS25 SAP code	COA	COA	COA	COA	COA	COA	COA	CAO	COA	COA	COA	COA	COA
D FP	132	152	182	202	232	252	302	352	402	452	502	552	652
A	380	400	430	450	480	500	550	600	650	700	750	800	900
ICS50 Ext Ømm	180	200	230	250	280	300	350	400	450	500	-	600	-
ICS50 SAP code	COA	COA	COA	COA	COA	COA	COA	CAO	COA	COA	-	COA	-
D FP	232	252	282	302	352	402	452	502	552	602	-	702	-
A	480	500	530	550	600	650	700	750	800	850	-	950	-

Support components

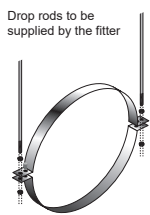

Ceiling hanger													
Int Ømm	80	100	130	150	180	200	250	300	350	400	450	500	600
ICS25 Ext Ømm	130	150	180	200	230	250	300	350	400	450	500	550	650
ICS25 SAP code	110118	110199	110392	112037	112279	112503	112870	129129	112863	129589	129789	129938	130163
ICS50 Ext Ømm	180	200	230	250	280	300	350	400	450	500	550	600	700
ICS50 SAP code	110392	112037	112279	112503	128623	112870	129129	112863	129589	129789	129938	130034	130243

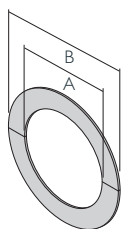

Trim collar 2 piece 90° plain							
Int Ømm	80	100	130	150	180	200	250
ICS25 Ext Ømm	130	150	180	200	230	250	300
ICS25 SAP code	125719	126338	127040	127644	128057	128512	129007
A	134	154	184	204	234	254	304
B	280	300	330	350	380	400	450
ICS50 Ext Ømm	180	200	230	250	280	300	-
ICS50 SAP code	127040	127644	128057	128512	128649	129007	-
A	184	204	234	254	284	304	-
B	330	350	380	400	430	450	-

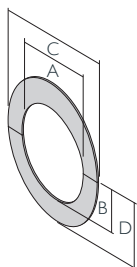

Trim collar 2 piece 45° plain							
Int Ømm	80	100	130	150	180	200	250
ICS25 Ext Ømm	130	150	180	200	230	250	300
ICS25 SAP code	125717	126335	127035	127639	128055	128510	129004
A	134	154	184	204	234	254	304
B	94	108	130	144	165	179	214
C	280	300	330	350	380	400	450
D	192	206	227	242	263	277	312
ICS50 Ext Ømm	180	200	230	250	280	300	-
ICS50 SAP code	127035	127639	128055	128510	128647	129004	-
A	184	204	234	254	284	304	-
B	130	144	165	179	200	214	-
C	330	350	380	400	430	450	-
D	227	242	263	277	298	312	-

Flashings

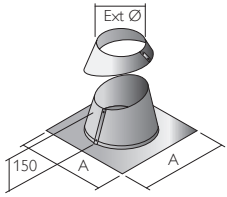

Angled flashing Kit 5-45° (aluminium)

Int Ømm	80	100	130	150	180	200	250	300
ICS25 Ext Ømm	130	150	180	200	230	250	300	350
ICS25 SAP code	125487	125889	126621	127197	127753	128195	120884	129128
A	610	610	610	700	700	700	800	860
ICS50 Ext Ømm	180	200	230	250	280	300	350	
ICS50 SAP code	126621	127197	127753	128195	128622	120884	129128	
A	610	700	700	700	800	800	860	

Flat flashing Kit (aluminium)

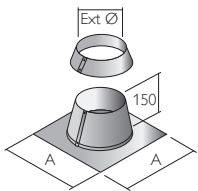

Int Ømm	80	100	130	150	180	200	250	300	350	400	450	500	600
ICS25 Ext Ømm	130	150	180	200	230	250	300	350	400	450	500	550	650
ICS25 SAP code	125490	125892	126625	127201	127756	128192	128699	129132	129408	129592	129792	129941	130166
A	610	610	610	610	610	610	610	610	610	610	610	610	610
ICS50 Ext Ømm	180	200	230	250	280	300	350	400	450	500	550	600	700
ICS50 SAP code	126625	127201	127756	128192	128699	129132	129408	129592	129792	129941	129941	130037	130246
A	610	610	610	610	610	610	610	610	610	610	610	-	-

Storm collar (stainless steel)

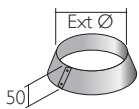

Int Ømm	80	100	130	150	180	200	250	300	350	400	450	500	600
ICS25 Ext Ømm	130	150	180	200	230	250	300	350	400	450	500	550	650
ICS25 SAP code	106136	106138	106140	106141	106142	106143	106144	106145	106146	106147	106148	100981	130169
ICS50 Ext Ømm	180	200	230	250	280	300	350	400	450	500	550	600	700
ICS50 SAP code	106140	106141	106142	106143	100971	106144	106145	106146	106147	106148	100981	100982	100984

Uniflash

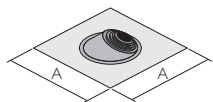

Type	Uniflash 80 - 130	Uniflash 130-300	Uniflash 250-450
A	500	685	800
ICS25 Int Ømm	80 - 100	100 - 200	200 - 400
ICS25 Ext Ømm	130 - 200	130 - 300	250 - 450
ICS25 SAP code	112198	112197	114341
ICS50 Int Ømm		80 - 200	150 - 350
ICS50 Ext Ømm		130 - 300	250 - 450
ICS50 SAP Code		112197	114341

Terminals

Terminal section



Int Ømm	80	100	130	150	180	200	250	300	350	400	450	500	600
ICS25 Ext Ømm	130	150	180	200	230	250	300	350	400	450	500	550	650
ICS25 SAP code	COA	COA	113540	114971	115367	115699	116223	117061	115122	117859	119276	118448	COA
A	155	155	155	155	155	155	155	155	155	155	155	155	155
Weight (kg)	1.51	1.70	1.97	2.53	2.85	3.4	3.61	4.68	5.67	6.29	6.94	8.18	8.43
ICS50 Ext Ømm	180	200	230	250	280	300	350	400	450	500	550	600	700
ICS50 SAP code	114198	119299	115426	115744	116052	116211	117074	117540	117866	121047	121048	121049	121050
Weight (kg)	1.97	2.53	2.85	3.06	3.40	3.61	4.68	5.67	6.29	6.94	8.18	9.09	10.91

Exhaust terminal (vertical) + locking band

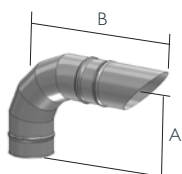

Int Ømm	80	100	130	150	180	200	250	300	350	400	450	500	600
ICS25 Ext Ømm	130	150	180	200	230	250	300	350	400	450	500	550	650
ICS25 SAP code	COA	COA	COA	126251	126944	127550	128467	128967	129321	129538	COA	COA	COA
A	223	236	248	261	273	286	312	376	401	426	451	476	526
B	442	475	518	550	592	625	700	814	889	964	1039	1114	1264
Weight (kg)	1.30	1.57	1.97	2.29	2.75	3.11	4.02	5.50	6.71	8.19	9.99	12.19	14.87
ICS50 Ext Ømm	180	200	230	250	280	300	350	400	450	500	550	600	700
ICS50 SAP code	COA	COA	COA	COA	COA	127551	COA	COA	COA	COA	COA	COA	COA
A	248	261	273	286	299	312	376	401	426	451	476	510	570
B	518	550	592	625	668	700	814	889	964	1039	1114	1200	1385
Weight (kg)	1.97	2.29	2.75	3.11	3.63	4.02	5.50	6.71	8.19	9.99	12.19	14.44	17.33

Exhaust terminal (horizontal) + locking band

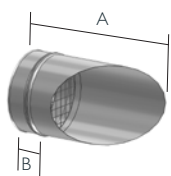

Int Ømm	80	100	130	150	180	200	250	300	350	400	450	500	600
ICS25 Ext Ømm	130	150	180	200	230	250	300	350	400	450	500	550	650
ICS25 SAP code	COA	COA	COA	111333	111704	111991	112782	112784	114719	115329	116046	116638	COA
A	255	275	305	325	355	375	425	475	525	575	625	675	775
Weight (kg)	0.47	0.56	0.72	0.84	1.02	1.16	1.52	1.91	2.36	2.83	3.40	4.08	4.90
ICS50 Ext Ømm	180	200	230	250	280	300	350	400	450	500	550	600	700
ICS50 SAP code	COA	COA	COA	COA	COA	127546	COA	128459	COA	129316	COA	COA	COA
A	305	325	355	375	405	425	475	525	575	625	675	725	825
B	125	125	125	125	125	125	125	125	125	125	125	125	125
Weight (kg)	0.72	0.84	1.02	1.16	1.37	1.52	1.91	2.36	2.83	3.4	4.08	4.75	5.94

Tapered terminal + locking band

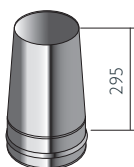

Int Ømm	80	100	130	150	180	200	250	300	350	400	450	500	600
ICS25 Ext Ømm	130	150	180	200	230	250	300	350	400	450	500	550	650
ICS25 SAP code	120565	148392	112378	101215	113141	101217	114704	115212	115841	101221	116479	101223	117352
A	205	205	205	205	205	205	205	205	205	205	205	205	205
Weight (kg)	0.88	1.05		1.48		1.91	2.34	2.76	3.2	3.39	3.93	4.34	5.16
ICS50 Ext Ømm	180	200	230	250	280	300	350	400	450	500	550	600	700
ICS50 SAP code	112119	119286	113325	114311	114769	114999	115700	116184	116618	118163	105375	118743	105377
A	205	205	205	205	205	205	205	205	205	205	205	205	205
Weight (kg)	1.21	1.50	1.85	2.08	2.38	2.57	3.06	3.55	4.04	7.27	8.51	9.88	12.90

Deflector cowl with drainpoint

Deflector cowls can be made as a special. Please contact our technical department for additional information



Load bearing information

Max loading ICS25 5000

int Ø mm	80	100	130	150	180	200	230	250	300	350	400	450	500	600
Base drain section	22	22	22	18	18	18	18	18	18	12	12	12	10	10
Top plate with drain	15	15	15	15	15	15	15	15	15	12	12	12	10	8
Top plate + locking band	15	15	15	15	15	15	15	15	15	12	12	12	10	8
Telescopic floor support	18	18	18	18	18	18	18	18	18	6	6	6	4	4
Pair of side plates (see diagram A)	15	15	15	15	15	15	15	15	15	12	12	12	10	8
Pair of side plates (see diagram B)	10	10	10	10	10	10	10	10	10	10	10	10	6	6
Cantilever support	15	15	15	15	15	15	15	15	15	12	12	12	10	8
Ceiling hanger	1.5	1.5	1.5	1.5	1.5	1.5	1.5	1.5	1.5	1.5	1.5	1.5	1.5	1.5
Heavy duty wall band	4	4	4	4	4	4	4	4	4	3	3	3	3	3
Extension for heavy duty wall band	4	4	4	4	4	4	4	4	4	3	3	3	3	3
Guy wire bracket	1.5	1.5	1.5	1.5	1.5	1.5	1.5	1.5	1.5	1.5	1.5	1.5	1.5	1.5
90° tee + locking band	22	22	22	18	18	18	18	18	18	6	6	6	6	4
135° tee + locking band	15	15	15	10	10	10	10	10	10	3	3	3	3	2
Inspection tee (round)	22	22	22	18	18	18	18	18	18	6	6	6	6	4

Max loading ICS50 5000

int Ø mm	80	100	130	150	180	200	230	250	300	350	400	450	500	600
Base drain section	22	22	22	18	18	18	18	18	18	12	12	12	10	10
Top plate with drain	15	15	15	15	15	15	15	15	15	12	12	12	10	10
Top plate + locking band	15	15	15	15	15	15	15	15	15	12	12	12	10	10
Telescopic floor support	18	18	18	18	18	18	18	18	18	6	6	6	4	4
Pair of side plates (see diagram A)	15	15	15	15	15	15	15	15	15	12	12	12	10	8
Pair of side plates (see diagram B)	10	10	10	10	10	10	10	10	10	10	10	10	6	6
Cantilever support	15	15	15	15	15	15	15	15	15	12	12	12	10	8
Ceiling hanger	1.5	1.5	1.5	1.5	1.5	1.5	1.5	1.5	1.5	1.5	1.5	1.5	1.5	1.5
Heavy duty wall band	4	4	4	4	4	4	4	4	4	3	3	3	3	3
Extension for heavy duty wall band	4	4	4	4	4	4	4	4	4	3	3	3	3	3
Guy wire bracket	1.5	1.5	1.5	1.5	1.5	1.5	1.5	1.5	1.5	1.5	1.5	1.5	1.5	1.5
90° tee + locking band	22	22	22	18	18	18	18	18	18	6	6	6	6	4
135° tee + locking band	15	15	15	10	10	10	10	10	10	3	3	3	3	2
Inspection tee (round)	22	22	22	18	18	18	18	18	18	6	6	6	6	4

DIAGRAM A

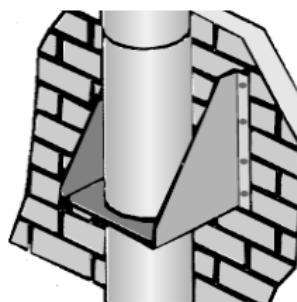
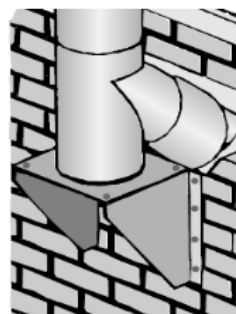
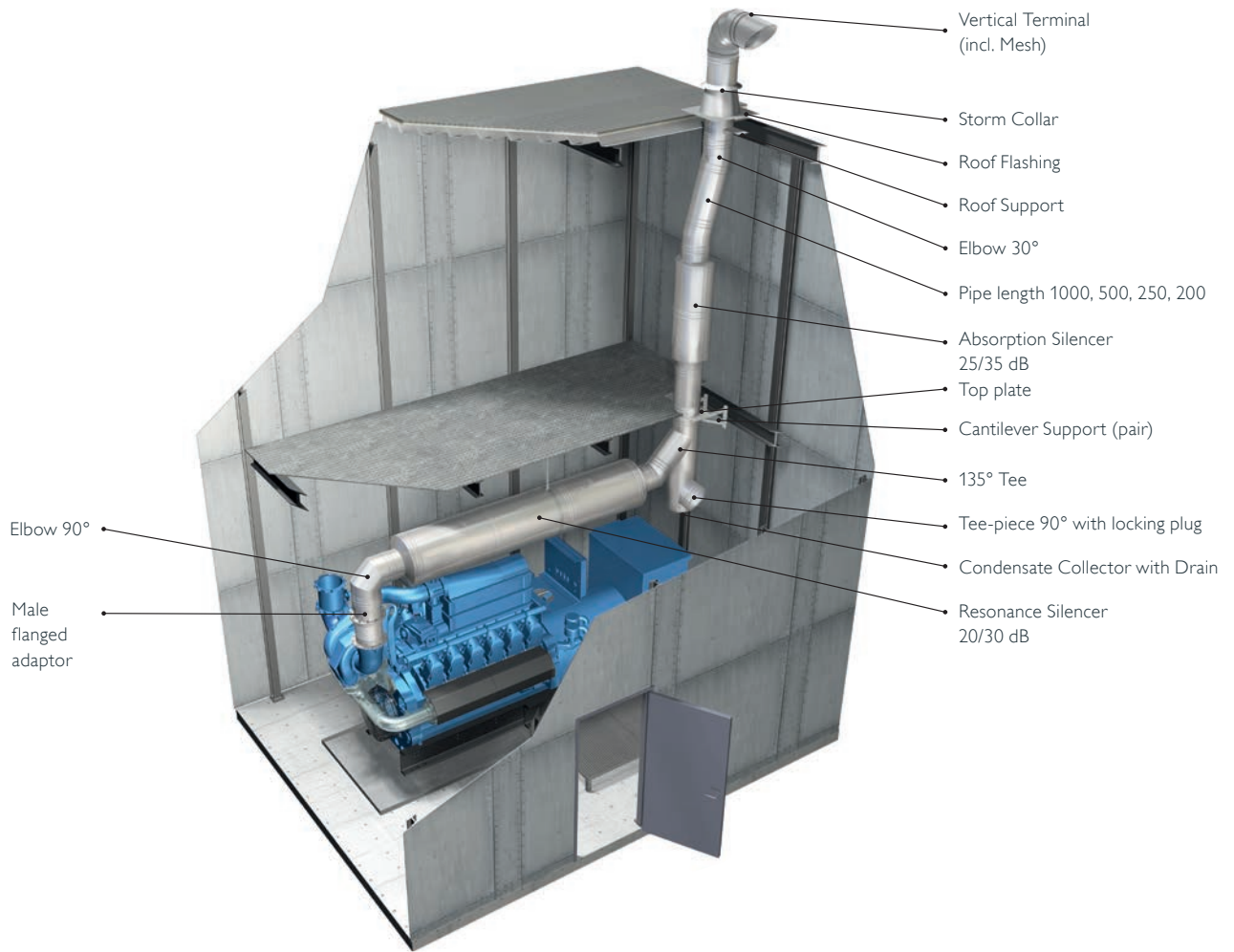

DIAGRAM B



Vertical application



Horizontal application

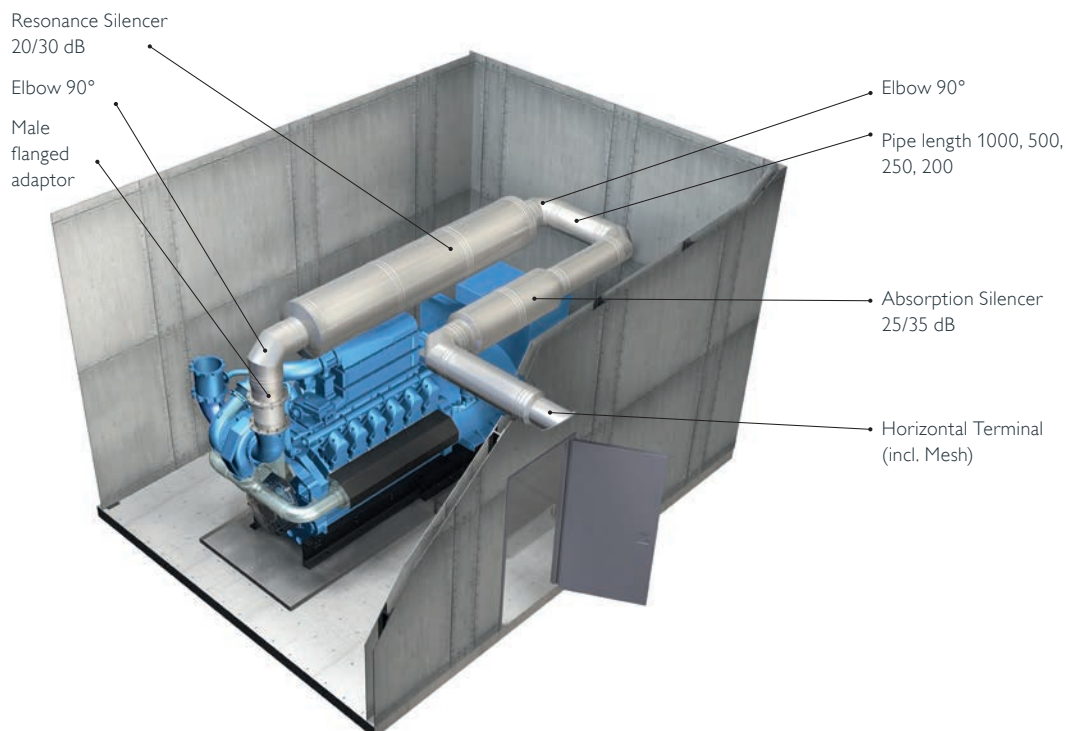

Load bearing information

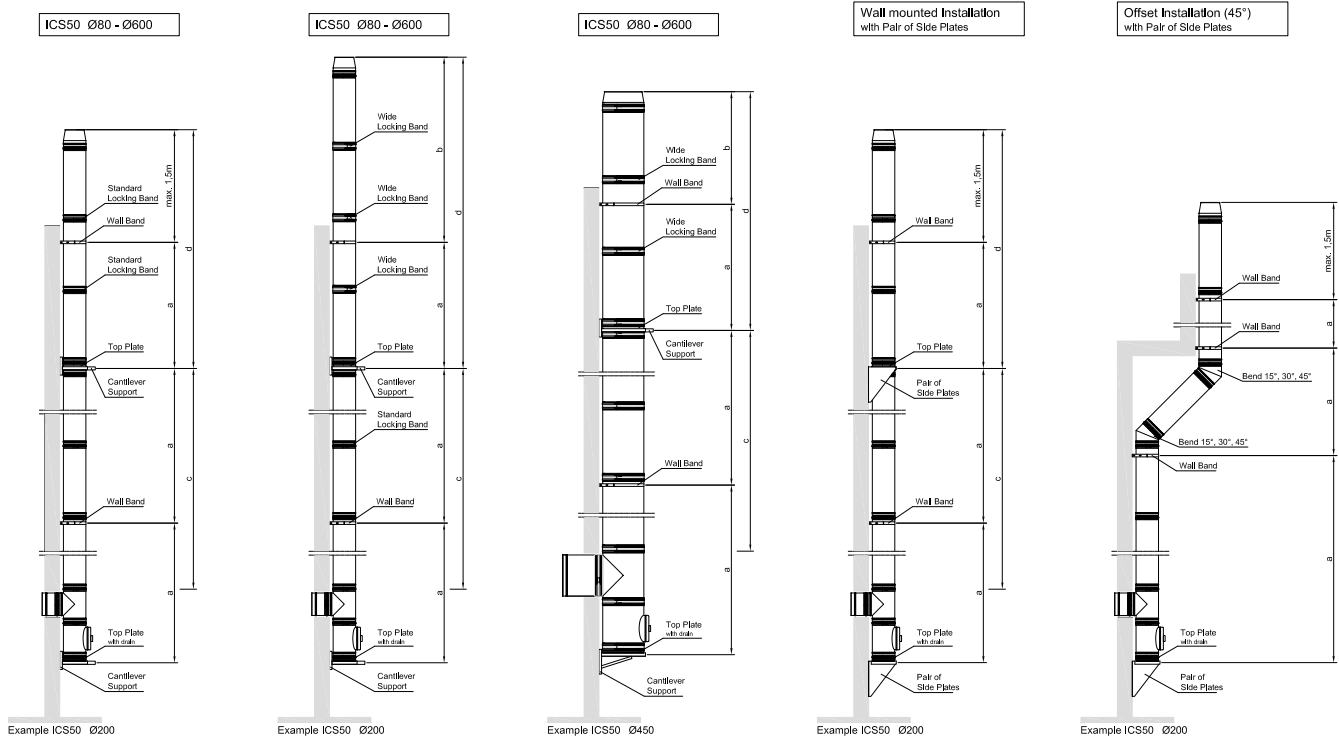

Max distance between supports ICS25 5000

Int diam (mm)	a	b	c	d
80	4	1.5	15	15
100	4	1.5	15	15
130	4	1.5	15	15
150	4	1.5	15	15
180	4	1.5	15	15
200	4	1.5	15	15
230	4	1.5	15	15
250	4	1.5	15	15
300	4	1.5	15	15
350	3	1.5	8	12
400	3	1.5	8	12
450	3	1.5	8	12
500	3	1.5	8	12
600	3	1.5	6	8

Max distance between supports ICS50 5000

Int diam (mm)	a	b	c	d
80	4	1.5	15	15
100	4	1.5	15	15
130	4	1.5	15	15
150	4	1.5	15	15
180	4	1.5	15	15
200	4	1.5	15	15
230	4	1.5	15	15
250	4	1.5	15	15
300	4	1.5	15	15
350	3	1.5	8	12
400	3	1.5	8	12
450	3	1.5	8	12
500	3	1.5	8	12
600	3	1.5	6	8



Schiedel

WE HAVE THE COMPLETE SERVICE

Whether it's a biomass flue solution, a multi-flue chimney, a fan dilution system or a generator exhaust, we have a product to suit every commercial or industrial application.

We offer the full engineering and technical support. Both in the private and public-sector Schiedel has unrivalled experience that you can rely on whatever the scale or nature of your project is – from chimneys to exhaust and venting systems.

Schiedel is well-known for collaborating closely with customers. We always offer our customers the best possible service. On-site, our technical team can provide site analysis and application advice as required.

We design and manufacture for projects in Europe and all over the world, and arrange for on-site installation from a small commercial installation to a large industrial.





Top level services

Site survey
System selection for optimum cost and performance
System sizing
Design and layout drawings
On-site installation
Ongoing technical support including facilities management

TYPICAL APPLICATIONS

CHIMNEY SYSTEMS

Fluing systems for biomass, gas and oil boilers
Natural draught
Fan assisted/positive pressure
Fan dilution
Condensing
Modular header

EXHAUST SYSTEMS

Generators, turbines, CHP

OTHER VENTING SYSTEMS

Process plant
Bakery ovens
Smoke extraction
Passive ventilation
Fire rated service duct, cable duct
Rubbish chutes

SUPPORT SYSTEMS

Building supported, internal, external
Mast supported, free standing single/multi-leg
Windshield
Relining existing stack



SCHIEDEL

Schiedel Chimney Systems
Crowther Estate, Washington
Tyne & Wear NE38 0AQ
Tel. +44 (0)191 416 1150

sales.uk@schiedel.com
schiedel.com/uk

Follow us on Social Media @SchiedelUK



A **standard**
INDUSTRIES COMPANY