



HIGH POSITIVE
PRESSURE SYSTEM

ICS 5000

Installation Instructions

SCHIEDEL

Contents

Contents.....	2
Approvals section.....	3
Design guide.....	4
Prior to Installation	4
Connecting flue pipe/system chimney	5
Installation instructions.....	6
Tees	9
Bends.....	10
Wall / floor penetration	15
Fire stop plate EI120	15
Support components.....	17
Typical external installations.....	25
Component weights	27
Useful guides	27

Approvals section

ICS 5000 is tested and approved in both 25mm and 50mm variants to BS EN 1856-1 as a System Chimney and to BS EN 1856-2 as a connecting flue pipe with the following designations

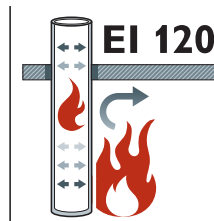

Schiedel is the first European chimney manufacturer to have performed the tests according to this latest fire resistance standard for chimneys.

System Chimney BS EN 1856-1 (TÜV 0036 CPR 9195 027)

ICS25 5000	ICS50 5000
T600 H1 DV3 L50050 O75*	T600 H1 DV3 L50050 O25*
T200 H1 WV2 L50050 O50**	
*Distance to Combustibles	*Distance to Combustibles
*Ø80-Ø300 distance - 75mm	*Ø80-Ø300 distance - 25mm
*Ø350-Ø450 distance - 112.5mm	*Ø350-Ø450 distance - 37.5mm
*Ø500- Ø600 distance - 150mm	*Ø500- Ø600 distance - 50mm
**Ø80-Ø200 distance - 50mm	

Connecting Flue Pipe BS EN 1856-2 (TÜV 0036 CPR 9195 038)

T600 H1 DV3 L50050 O100 M

Connecting Flue Pipe BS EN 1856-2 (TÜV 0036 CPR 9195 036)

T600 H1 DV3 L50050 O100 M

EI 120 Fire rating to BS EN 1366-13 Chimneys

ICS25 5000	ICS50 5000
Horizontal and Vertical	Horizontal and Vertical

BS 476 part 20 (4 Hour Fire Rating)

ICS25 5000	ICS50 5000

Corrosion testing on Gas, Oil, Solid Fuel (TÜV 0036 CPR 9195 027)

Gastec, MPA, TÜV

Schiedel has successfully carried out fire resistance tests according to the latest European standard BS EN 1366-13:2019 "Fire resistance tests for service installations, Part 13: Chimneys" and has reached EI 120 classification for our Double Wall Insulated System Chimney ICS in a closed scenario (type A) for both vertical and horizontal set-ups.



For all the latest approval information and DOP's please refer to our website.

Design guide

MANDATORY REQUIREMENTS

Connection to an appliance which is not connected to the fuel supply, should be carried out by a competent person. The installation must be certified by a local Building Control inspector. Connection to an appliance that is connected to the fuel supply must be carried out by a Gas Safe (Gas) or OFTEC (Oil) registered installer.

The design guide must be read in conjunction with any detailed component installation instructions. For full design and installation details the key referral documents are:

BS EN 1856-1: Chimneys - System Chimney Products

BS EN 1856-2: Connecting Flue Pipes

BS EN 1859: Metal Chimneys - Testing Methods

BS EN 1443: Chimneys - General Requirements

BS EN 15287-1: Chimneys. Design, installation and commissioning of chimneys. Chimneys for non-room sealed heating appliances.

Appliance Installation Instructions and related standards. Other standards covering specific applications will also be relevant and must be adhered to.

Planning permission may be required, and reference should be made to the local Building Control Department.

Ensure all chimney components are available and check them to ensure there has been no damage. Do not use damaged components. Build the chimney up through the previously designed route which should be as straight as possible.

Prior to Installation

VENTILATION

It is very important that sufficient air for combustion and ventilation is provided to the room containing the appliance, to enable correct and efficient working of the appliance and chimney system. Reference should be made to the appliance manufacturer's instructions and recommendations are also given in CIBSE guidance notes and BS 5440.

CARBON MONOXIDE ALARMS

The carbon monoxide alarms should comply with BS EN 50291 N.B Provision of a carbon monoxide alarm should not be regarded as a substitute for correct installation and regular servicing.

PAINTING

If painting of any external sections is required, it is important to de-grease, dry and prime the exterior surface prior to the application of appropriate heat resistant paint. Schiedel Chimney Systems can provide to special order; chimney sections and accessories painted to an extensive range of British Standard RAL colours – details on application.

Please note that conditions in coastal areas means that corrosion is more likely to occur. Please contact us for advice on any such installation.

HANDLING

It is advised that suitable PPE should be used when handling the products.

DELIVERY TO SITE AND STORAGE

Components should be carefully transported and off loaded. They should be inspected to ensure they have not been damaged, and should be stored off the ground and under cover so that they are protected from accidental damage and the adverse effects of weather.

Connecting flue pipe/system chimney

APPLIANCE/CHIMNEY CONNECTION

Connection to the appliance on a diesel generator is made starting from a flanged connector provided by the appliance manufacturer.

The connecting flue pipe must be positioned to keep the recommended distance to any combustible materials in line with the approval information on p.3 of these instructions.

CONNECTING FLUE PIPE DIAMETER

The chimney size should be as recommended by the appliance manufacturer. The operational requirements of the appliance of the appliance and the configuration of the flue must satisfy the flue sizing requirements of BS EN13384-1

DISTANCE TO COMBUSTIBLES

Where the chimney penetrates a non combustible floor and where a non combustible shaft is used, the distance to combustibles must be adhered to (see designations on page 3).

E1120 FIRE RATING

The most important detail in fire safe installation of the ICS 5000 chimney is the penetration through the wall or the floor as it must prevent the spread of fire from one compartment to the other. It has to be carried in exactly the same way and with same materials as described in the section from p.15.

SUPPORT COMPONENTS

The weight of a chimney system is considerable and requires independent support. Minimal weight should be borne by the appliance. The weight of the chimney can be supported from floor level by using a base support plate, or floor support; from the wall by using wall support top plates together with side plates or cantilever brackets, or from the ceiling using ceiling hangers to support horizontal runs.

Wall brackets are non load bearing and provide lateral support only. Refer to the load bearing tables on page 26 for full details of maximum loadings.

Where the flue is freestanding above the roof and its height exceeds 1.5m above the last support or above the roof, a height of up to 3m can be achieved unsupported using the extended locking bands at the joint immediately below the last support and on each pipe joint above the last support. (Please refer to the table on p.25 for the maximum free standing heights by diameter).

Alternatively guy wire brackets can be used at the 1.5m level and every 1.5m thereafter in conjunction with guy wires, or rigid stays (provided by others).

Installation instructions

JOINTING SYSTEM

All joints in the ICS 5000 chimney range, which require a locking band, are made by means of a simple push fit jointing method. This is achieved by the engineered spigot and socket system having a pronounced lead-in-edge to ease assembly.

On all ICS5000 components with a male form on the case, a lip seal is pre-fitted into the inward bead, which makes the product suitable for applications with an H1 (High positive pressure) requirement.

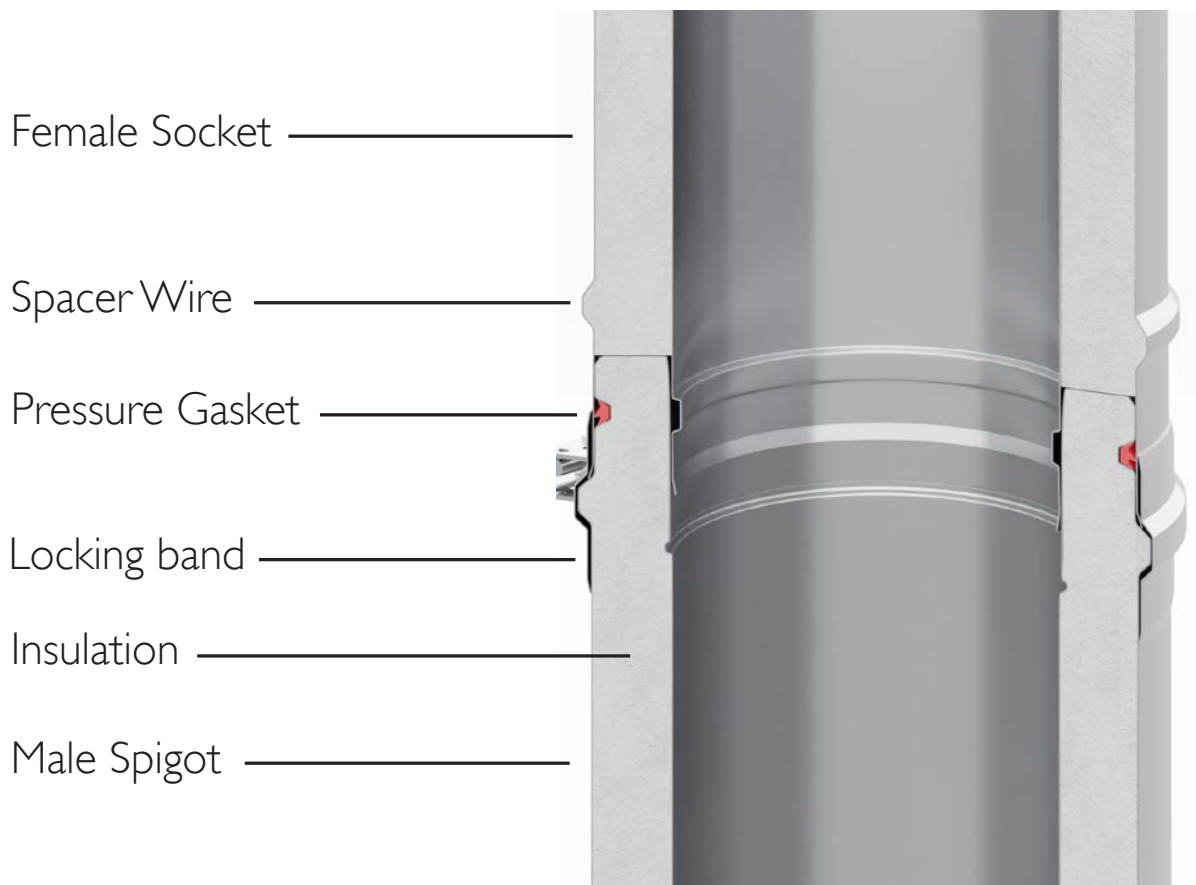

STANDARD CHIMNEY SECTIONS (PIPES, TEES AND ELBOWS)

Before assembling chimney sections, slip a locking band over female socket of the chimney section. Ensure the sections are pushed tightly together; before securing the locking band by use of the quick release clip. The clip can then be tightened into place by using the tightening bolt. Note:-joints must NOT occur within floor or ceiling spaces.

All flue gas carrying components must be installed with the direction arrow on the product label pointing to termination with the external male spigot of the case uppermost.

Installation instructions

LOCKING BAND (SUPPLIED WITH EACH COMPONENT WITH A FEMALE SOCKET ON THE CASE)

A locking band must be fitted to every joint in the system. The band is of stainless steel construction and is fitted with a quick release clip and a stainless steel tightening bolt. The bolt can be adjusted to ensure the joint is firmly secured.

STRUCTURAL LOCKING BAND

The structural locking band, which is purchased separately, is used instead of a standard locking band in a situation where extra structural support is required, for instance where the chimney height is >1.5m above the last support or above the roof. It is also used to provide extra support in long horizontal runs. A maximum of 3m unsupported height can be achieved by fitting the structural locking band on the joint immediately below and on every joint above the last support. Check table on p.25 for maximum heights relating to diameter.

FLANGED CONNECTOR TO ICS AND FLANGED CONNECTOR FROM ICS 5000

Schiedel provide standard flanged adaptors to and from ICS5000, which are made to suit the appliance manufacturer's flanged fitting.

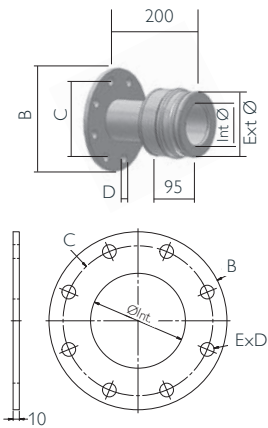

Male flanged adaptor & gasket with 10mm flange

Int Ømm	80	100	130	150	180	200	250	300	350	400	450	500	600
ICS25 Ext Ømm	130	150	180	200	230	250	300	350	400	450	500	550	650
ICS25 SAP code	110960	COA	112923	116875	114448	114462	114930	115656	115289	113781	113782	115587	115608
ICS50 Ext Ømm	180	200	230	250	280	300	350	400	450	500	550	600	700
ICS50 SAP Code	COA	COA	COA	COA	COA	COA	COA	COA	COA	COA	COA	COA	COA
B	200	220	250	285	315	340	395	445	505	565	615	670	780
C	160	180	210	240	270	295	350	400	460	515	565	620	725
D	18	18	18	22	22	22	22	22	22	22	26	30	30
E (Qty of D)	8	8	8	8	8	8	12	12	16	16	20	20	20

* B, C, D, E info applies to both ICS25 and ICS50 ranges

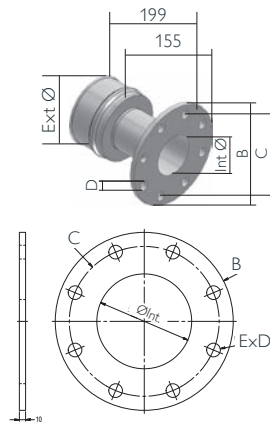

Female flanged adaptor with 10mm flange

Int Ømm	80	100	130	150	180	200	250	300	350	400	450	500	600
ICS25 Ext Ømm	130	150	180	200	230	250	300	350	400	450	500	550	650
ICS25 SAP code	114232	COA	116591	116810	117212	117519	117270	117739	118723	COA	COA	COA	COA
ICS50 Ext Ømm	180	200	230	250	280	300	350	400	450	500	550	600	700
ICS50 SAP Code	COA	COA	COA	COA	COA	COA	COA	COA	COA	COA	COA	COA	COA
B	200	220	250	285	315	340	395	445	505	565	615	670	780
C	160	180	210	240	270	295	350	400	460	515	565	620	725
D	18	18	18	22	22	22	22	22	22	22	26	30	30
E (Qty of D)	8	8	8	8	8	8	12	12	16	16	20	20	20

* B, C, D, E info applies to both ICS25 and ICS50 ranges

The two flanges should be pressed together and sealed using Schiedel high temperature sealing compound, then bolted firmly in place.

Installation instructions

If the design of the manufacturer's flange is different from Schiedel's standard flanged adaptor, then please provide the details of the non standard flange as shown in the table below referring to the image below:

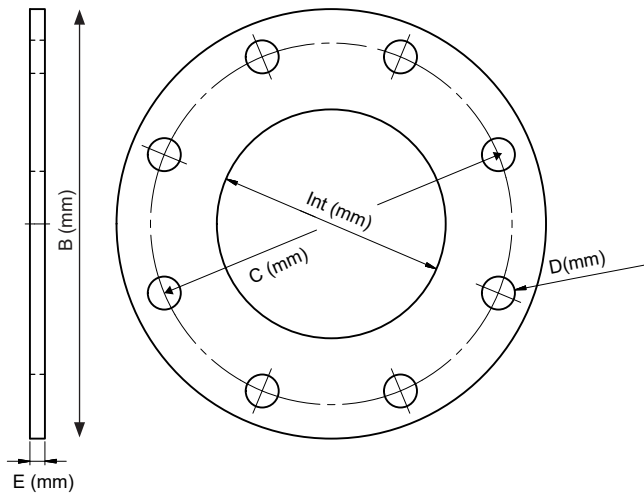

To be completed by customer	
According to standard	
Internal diameter (mm)	
External diameter (mm) B	
Pitch diameter (mm) C	
Hole diameter (mm) D	
Quantity of holes	
Flange thickness (mm) E	
Material grade:	
Comments:	

Non-standard flange (made to special order)

Int Ømm	80	100	130	150	180	200	250	300	350	400	450	500	600
ICS25 Ext	130	150	180	200	230	250	300	350	400	450	500	550	650
ICS50 Ext	180	200	230	250	280	300	350	400	450	500	550	600	700

Used in combination with the plain end adaptor below:

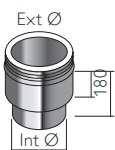

Plain end adaptor to ICS5000 with gasket

Int Ømm	80	100	130	150	180	200	250	300	350	400	450	500	600
ICS25 Ext	130	150	180	200	230	250	300	350	400	450	500	550	650
ICS25 SAP code	110415	110635	110858	112072	112879	112071	112761	113103	115414	116191	116595	116930	117403
ICS50 Ext	180	200	230	250	280	300	350	400	450	500	550	600	700
ICS50 SAP Code	111454	111942	112639	112939	113286	114186	114918	115181	115179	115983	115982	115981	117283

SILENCERS

Care should be taken when installing silencers to ensure that the the weight is supported using ceiling hangers in the horizontal. Lifting eyes are standard on all resonance silencers.

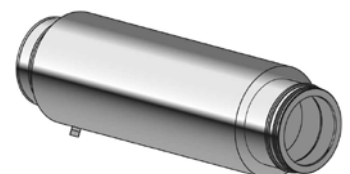

Installation instructions

ADJUSTABLE PIPE

The adjustable pipes are delivered as two pre-assembled sections with a joint band and locking band (see Fig.1). They are used with standard components to achieve an exact length on site and avoid on-site cutting of components.

1. Calculate the length required. Loosen the joint band and remove the top section of the adjustable pipe.
2. Remove insulation as required to achieve the correct length.
3. Apply lubricant from the sachet to the inside of the the case.
4. Re-assemble the pipe and cover the joint with the joint band.
5. Fix the adjusted section to standard components using the locking band provided.

Please note that the adjustable pipe is non load bearing.

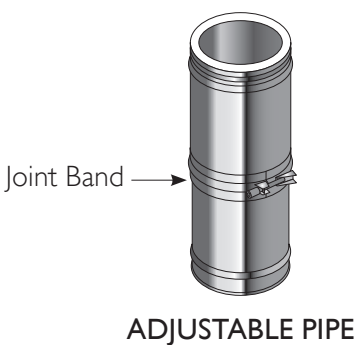
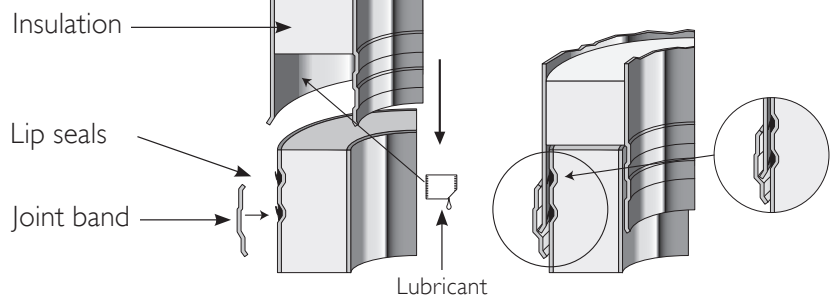
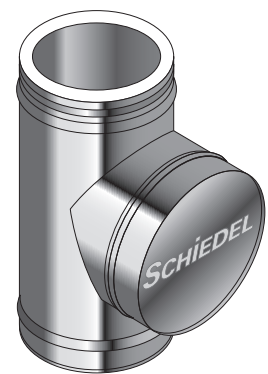

FIG. 1



INSPECTION TEE

The inspection length is a component providing the facility for flue inspection and cleaning. It is installed as per a standard pipe section.



INSPECTION LENGTH

VERTICAL DRAIN PIPE

This component is used to provide the facility to drain off rainwater or condensate from the chimney. It is installed in the same way as a standard pipe. It is provided as standard with a 3/4" BSP fitting.

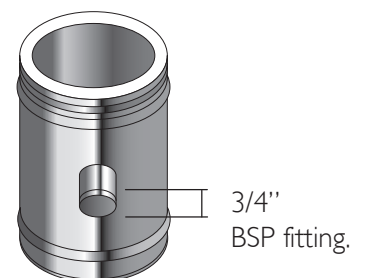

Tees

90° TEE

This component may be used to connect from a connecting flue pipe to the vertical system chimney at 90°. It is installed as per a standard pipe section.

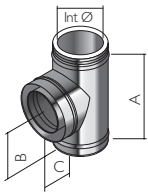

90° tee + locking bands and gasket

Int Ømm	80	100	130	150	180	200	250	300	350	400	450	500	600
ICS25 Ext	130	150	180	200	230	250	300	350	400	450	500	550	650
ICS25 SAP	120563	120564	116097	116451	117026	117293	117947	118372	113617	113616	119261	114129	114132
A	288	288	455	455	455	455	455	480	530	605	655	705	805
B	126	126	209	209	209	209	209	222	247	285	310	335	385
C	105	115	130	140	155	165	190	205	240	280	305	330	380
Weight (kg)	1.63	1.95	3.42	3.88	4.57	5.04	6.56	7.9	10.39	13.36	15.51	18.7	23.5
ICS50 Ext	180	200	230	250	280	300	350	400	450	500	550	600	700
ICS50 SAP	117843	117157	117847	118542	118548	118546	113595	113883	113887	113886	113884	113885	118073
A	455	455	455	455	455	455	480	530	605	655	705	755	855
B	209	209	209	209	209	209	222	247	285	310	335	360	410
C	130	140	155	165	180	190	205	240	280	305	330	355	405
Weight (kg)	3.85	4.81	6.23	7	7.97	8.62	10.22	13.61	16.79	32.26	38.48	45.23	60.3

135° TEE

This component may be used in combination with a 45° elbow to connect from a connecting flue pipe to the vertical system chimney. It is installed as per a standard pipe section and provides the least resistance to the flow of the flue gases.

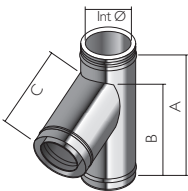

135° tee + locking bands and gasket

Int Ømm	80	100	130	150	180	200	250	300	350	400	450	500	600
ICS25 Ext	130	150	180	200	230	250	300	350	400	450	500	550	650
ICS25 SAP	113315	114935	116670	117054	117410	118016	118530	113725	113956	114114	115524	115600	116544
A	330	355	455	455	455	530	560	623	697	815	885	955	1100
B	218	246	328	329	322	378	413	472	530	615	675	735	855
C	219	245	328	328	325	376	410	469	530	615	675	735	855
ICS50 Ext	180	200	230	250	280	300	350	400	450	500	550	600	700
ICS50 SAP	119283	119285	119284	118533	113638	113732	114006	115501	115591	117234	117701	118072	118625
A	328	328	325	376	390	410	469	530	615	675	735	795	915
B	455	455	455	530	530	560	623	697	815	885	955	1030	1210
C	328	329	322	378	393	413	472	530	615	675	735	795	915

Bends

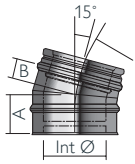

15° bend + locking band & gasket

Int Ømm	80	100	130	150	180	200	250	300
ICS25 Ext	130	150	180	200	230	250	300	350
ICS25 SAP	111090	120567	111847	112166	112627	112853	113433	114522
A	55	55	55	55	60	60	65	65
B	96	95	95	95	100	100	105	105
Weight (kg)	0.74	0.88	1.08	1.22	1.43	1.57	1.91	2.25
ICS50 Ext	180	200	230	250	280	300	350	400
ICS50 SAP	114294	114286	114296	114297	114298	114299	114300	116793
A	55	55	60	60	60	65	65	70
B	95	95	100	100	100	105	105	110
Weight (kg)	1.41	1.76	2.28	2.50	2.80	3.50	4.02	4.81

30° bend + locking band & gasket

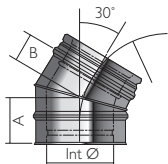

Int Ømm	80	100	130	150	180	200	250	300	350	400	450	500	600
ICS25 Ext	130	150	180	200	230	250	300	350	400	450	500	550	650
ICS25 SAP code	119624	111400	119265	112176	113251	120568	114817	115348	116898	117262	118002	118232	118740
A	55	60	68	70	75	80	85	90	100	122	127	132	147
B	95	100	107	110	115	120	125	130	140	166	171	176	191
Weight (kg)	0.74	0.88	1.08	1.22	1.80	1.98	2.42	2.84	4.42	5.00	6.71	7.63	9.83
ICS50 Ext	180	200	230	250	280	300	350	400	450	500	550	600	700
ICS50 SAP code	114671	114672	114673	114674	114679	114675	114691	114676	114686	114678	114670	114680	114681
A	67	70	75	80	80	85	90	100	105	127	132	142	157
B	107	110	115	120	120	125	130	140	145	171	176	186	201
Weight (kg)	1.40	1.75	2.33	2.64	3.12	3.50	4.29	5.16	6.26	7.75	8.83	10.24	13.36

45° bend + locking band & gasket

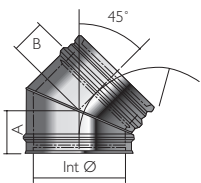

Int Ømm	80	100	130	150	180	200	250	300	350	400	450	500	600
ICS25 Ext	130	150	180	200	230	250	300	350	400	450	500	550	650
ICS25 SAP	111523	112804	112496	112810	113239	119267	115300	116375	116897	117275	118377	119263	113737
A	70	75	80	85	90	95	105	115	130	152	162	172	192
B	110	115	120	125	130	135	145	155	170	196	206	216	236
Weight (kg)	0.93	1.11	1.37	1.54	1.80	2.15	2.82	3.83	4.42	5.00	7.88	9.13	11.87
ICS50 Ext	180	200	230	250	280	300	350	400	450	500	550	600	700
ICS50 SAP	115204	115206	115203	115210	115205	116598	116599	116600	116601	116605	116611	113801	113800
A	80	85	90	95	105	105	115	130	140	162	172	182	202
B	120	125	130	135	145	145	155	170	180	206	216	226	246
Weight (kg)	1.68	2.10	2.75	3.08	3.62	4.03	5.08	6.25	7.50	9.36	10.87	12.48	16.32

90° bend + locking band & gasket

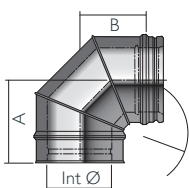

Int Ømm	80	100	130	150	180	200	250	300	350	400	450	500	600
ICS25 Ext	130	150	180	200	230	250	300	350	400	450	500	550	650
ICS25 SAP	112215	112764	114218	114507	115270	115846	116848	117564	118132	118551	113823	113979	115484
A	128	136	152	161	176	188	212	237	264	290	396	421	471
B	172	180	196	205	220	232	256	281	308	330	434	459	509
Weight (kg)	1.20	1.50	2.00	2.38	3.07	3.39	4.55	5.84	7.33	9.80	11.61	13.60	18.00
ICS50 Ext	180	200	230	250	280	300	350	400	450	500	550	600	700
ICS50 SAP	117441	117442	117454	117444	117449	113730	113728	113795	113797	114142	114141	115580	115578
A	152	161	176	188	204	212	237	264	290	396	421	446	497
B	196	205	220	232	248	256	281	308	330	434	459	484	535
Weight (kg)	2.00	2.40	3.28	3.90	5.03	5.56	7.46	9.58	12.02	16.94	19.05	22.31	29.52

Offsets (made by assembling 2 bends)

15° offset

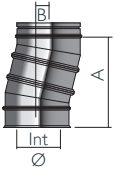

Int Ømm	80	100	130	150	180	200	250	300
ICS25 Ext Ømm	130	150	180	200	230	250	300	350
A	295	295	295	295	315	315	334	334
B	39	39	39	39	41	41	44	44
ICS50 Ext Ømm	180	200	230	250	280	300	350	400
A	295	295	315	315	315	334	334	354
B	39	39	41	41	41	44	44	47

30° offset

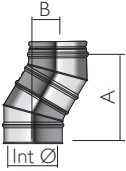

Int Ømm	80	100	130	150	180	200	250	300	350	400	450	500	600
ICS25 Ext Ømm	130	150	180	200	230	250	300	350	400	450	500	550	650
A	280	299	327	336	355	373	392	411	448	537	556	575	631
B	75	80	88	90	95	100	105	110	120	144	149	154	169
ICS50 Ext Ømm	180	200	230	250	280	300	350	400	450	500	550	600	700
A	327	336	355	373	373	392	411	448	467	556	575	612	668
B	88	90	95	100	100	105	110	120	125	149	154	164	179

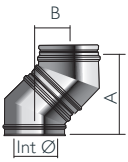

45° offset

Int Ømm	80	100	130	150	180	200	250	300	350	400	450	500	600
ICS25 Ext Ømm	130	150	180	200	230	250	300	350	400	450	500	550	650
A	307	324	341	358	376	393	427	461	512	594	628	662	731
B	127	134	141	148	156	163	177	191	212	246	260	274	303
ICS50 Ext Ømm	180	200	230	250	280	300	350	400	450	500	550	600	700
A	341	358	376	393	427	427	461	512	546	628	662	696	765
B	141	148	156	163	177	177	191	212	226	260	274	288	317

Offsets (made by assembling 2 bends)

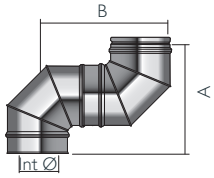

90° offset

Int Ømm	80	100	130	150	180	200	250	300	350	400	450	500	600
ICS25 Ext Ømm	130	150	180	200	230	250	300	350	400	450	500	550	650
A	322	337	372	391	424	450	500	552	609	641	852	907	1013
B	295	309	341	359	388	412	458	506	558	588	781	831	928
ICS50 Ext Ømm	180	200	230	250	280	300	350	400	450	500	550	600	700
A	348	366	396	420	452	468	518	572	620	830	880	930	1032
B	348	366	396	420	452	468	518	572	620	830	880	930	1032

Offsets for 135° tee & 45° bend

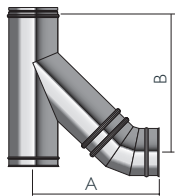

Int Ømm	80	100	130	150	180	200	250	300	350	400	450	500	600
ICS25 Ext Ømm	130	150	180	200	230	250	300	350	400	450	500	550	650
A	303	330	397	405	412	456	497	556	625	725	785	844	963
B	345	364	444	446	455	513	539	592	662	773	833	892	1016
ICS50 Ext Ømm	180	200	230	250	280	300	350	400	450	500	550	600	700
A	397	405	412	456	483	497	556	625	702	785	844	904	1023
B	444	446	455	513	515	539	592	662	762	833	892	957	1116

15° bend offset with standard pipe length

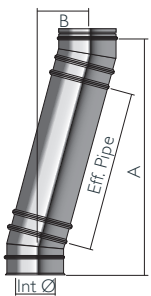

Int Ømm		80	100	130	150	180	200	250	300
ICS25 Ext Ømm		130	150	180	200	230	250	300	350
EFF Pipe	A	1218	1218	1238	1238	1238	1257	1257	1277
955	B	286	286	288	288	288	291	291	294
EFF Pipe	A	735	735	755	755	755	774	774	794
455	B	157	157	159	159	159	162	162	165
EFF Pipe	A	493	493	513	513	513	532	532	552
205	B	92	92	94	94	94	97	97	100
EFF Pipe	A	445	445	465	465	465	484	484	504
155	B	79	79	81	81	81	84	84	87
ICS50 Ext Ømm		180	200	230	250	280	300	350	400
EFF Pipe	A	1218	1218	1218	1218	1238	1238	1257	1257
955	B	286	286	286	286	288	288	291	291
EFF Pipe	A	735	735	735	735	755	755	774	774
455	B	157	157	157	157	159	159	162	162
EFF Pipe	A	493	493	493	493	513	513	532	532
205	B	92	92	92	92	94	94	97	97
EFF Pipe	A	445	445	445	445	465	465	484	484
155	B	79	79	79	79	81	81	84	84

Typical offsets (made by assembling 2 bends and a standard pipe section)

30° bend offset with standard pipe length

Int Ømm		80	100	130	150	180	200	250	300	350	400	450	500	600
ICS25 Ext Ømm		130	150	180	200	230	250	300	350	400	450	500	550	650
EFF Pipe	A	1107	1126	1154	1163	1182	1200	1219	1238	1275	1364	1383	1402	1458
955	B	553	558	566	568	573	578	583	588	598	622	627	632	647
EFF Pipe	A	674	693	721	709	765	765	784	793	920	931	950	969	1025
455	B	303	308	316	318	323	328	333	338	348	372	377	382	397
EFF Pipe	A	458	477	505	514	533	551	570	589	626	715	734	753	809
205	B	178	183	191	193	198	203	208	213	223	247	252	257	272
EFF Pipe	A	414	433	461	470	489	507	526	545	582	671	690	709	765
155	B	153	158	166	168	173	178	183	188	198	222	227	232	247

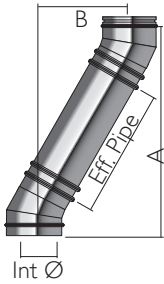

ICS50 Ext Ømm		180	200	230	250	280	300	350	400	450	500	550	600	700
EFF Pipe	A	1154	1163	1182	1183	1202	1221	1239	1258	1295	1383	1402	1439	1495
955	B	566	568	573	574	579	584	589	594	604	627	632	642	657
EFF Pipe	A	721	730	749	767	767	786	805	842	861	950	969	1006	1062
455	B	316	318	323	328	328	333	338	348	353	377	382	392	407
EFF Pipe	A	505	514	533	551	551	570	589	626	645	734	753	790	846
205	B	191	193	198	203	203	208	213	223	228	252	257	267	282
EFF Pipe	A	461	470	489	507	507	526	545	582	601	690	709	746	802
155	B	166	168	173	178	178	183	188	198	203	227	232	242	257

45° bend offset with standard pipe length

Int Ømm		80	100	130	150	180	200	250	300	350	400	450	500	600
ICS25 Ext Ømm		130	150	180	200	230	250	300	350	400	450	500	550	650
EFF Pipe	A	982	999	1016	1033	1051	1068	1102	1136	1187	1269	1303	1337	1406
955	B	802	809	816	823	831	838	852	866	887	921	935	949	978
EFF Pipe	A	629	646	663	680	698	715	749	783	834	916	950	984	1053
455	B	449	456	463	470	478	485	499	513	534	568	582	596	625
EFF Pipe	A	452	469	486	503	521	538	572	606	657	739	773	807	876
205	B	272	279	286	293	301	308	322	336	357	391	405	419	448
EFF Pipe	A	417	434	451	468	486	503	537	571	622	704	738	772	841
155	B	237	244	251	258	266	273	287	301	322	356	370	384	413

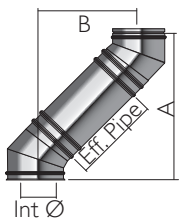

ICS50 Ext Ømm		180	200	230	250	280	300	350	400	450	500	550	600	700
EFF Pipe	A	1016	1033	1051	1068	1102	1102	1136	1187	1221	1303	1337	1371	1440
955	B	816	823	831	838	852	852	866	887	901	935	949	963	992
EFF Pipe	A	663	680	698	715	749	749	783	834	868	950	984	1018	1087
455	B	463	470	478	485	499	499	513	534	548	582	596	610	639
EFF Pipe	A	486	503	521	538	572	572	606	657	691	773	807	841	910
205	B	286	293	301	308	322	322	336	357	371	405	419	433	462
EFF Pipe	A	451	468	486	503	537	537	571	622	656	738	772	806	875
155	B	251	258	266	273	287	287	301	322	336	370	384	398	427

Typical offsets (made by assembling 2 bends and a standard pipe section)

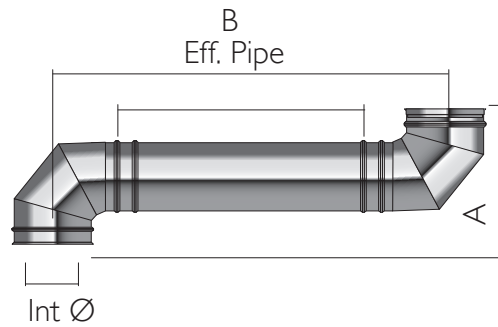

90° bend offset with standard pipe length

Int	80	100	130	150	180	200	250	300	350	400	450	500	600
-----	----	-----	-----	-----	-----	-----	-----	-----	-----	-----	-----	-----	-----

ICS25 Ext Ømm		130	150	180	200	230	250	300	350	400	450	500	550	650
EFF	A	300	316	348	366	396	420	468	518	572	620	830	880	980
955	B	1255	1271	1303	1321	1351	1375	1423	1473	1527	1575	1785	1835	1935
EFF	A	300	316	348	366	396	420	468	518	572	620	830	880	980
455	B	755	771	803	821	851	875	923	973	1027	1075	1285	1335	1435
EFF	A	300	316	348	366	396	420	468	518	572	620	830	880	980
205	B	505	521	553	571	601	625	673	723	777	825	1035	1085	1185
EFF	A	300	316	348	366	396	420	468	518	572	620	830	880	980
155	B	455	471	503	521	551	575	623	673	727	775	985	1035	1135

ICS50 Ext Ømm		180	200	230	250	280	300	350	400	450	500	550	600	700
EFF	A	348	366	396	420	452	468	518	572	620	830	880	930	1032
955	B	1303	1321	1351	1375	1407	1423	1473	1527	1575	1785	1835	1885	1987
EFF	A	348	366	396	420	452	468	518	572	620	830	880	930	1032
455	B	803	821	851	875	907	923	973	1027	1075	1285	1335	1385	1487
EFF	A	348	366	396	420	452	468	518	572	620	830	880	930	1032
205	B	553	571	601	625	657	673	723	777	825	1035	1085	1135	1237
EFF	A	348	366	396	420	452	468	518	572	620	830	880	930	1032
155	B	503	521	551	575	607	623	673	727	775	985	1035	1085	1187

Wall / floor penetration

DETAIL OF THE PENETRATION THROUGH THE WALL / FLOOR

The most important detail in fire safe installation of the ICS chimney is the penetration through the wall or the floor as it must prevent the spread of fire from one compartment to the other. It has to be carried in exactly the same way and with same materials as described in this section.

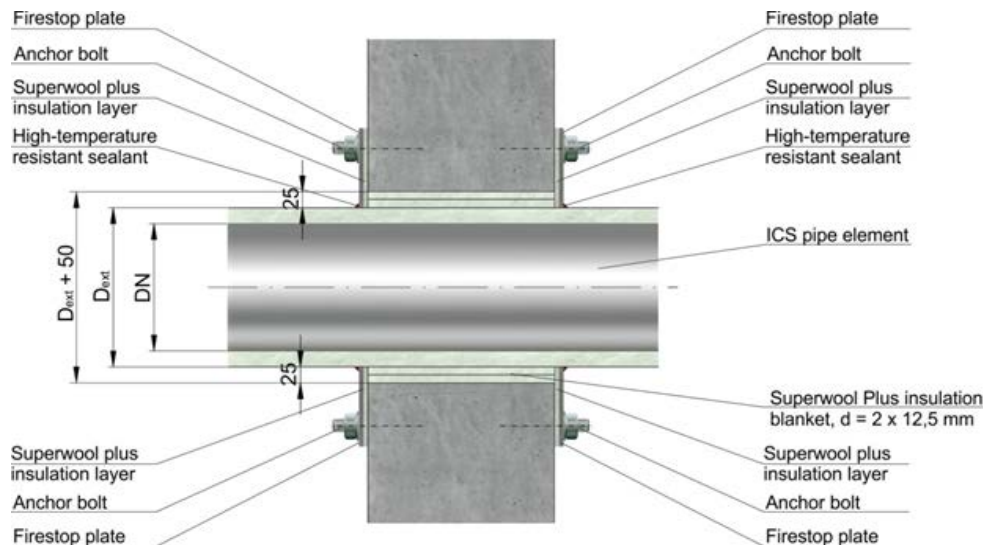

Fire stop plate EI120

The bore hole in a wall/floor should have a diameter 50mm larger than the outer diameter of the chimney. When the chimney pipe is inserted through the opening, a 25 mm gap should remain between the pipe and the bore hole. The gap should be filled with Superwool Plus insulation blanket. The nominal thickness of the blanket we supply is 12,5 mm, thus it should be wrapped around the pipe twice to reach the required 25 mm thickness.

In order to insert the blanket into this gap, we recommend wrapping the blanket tightly around the pipe section. To secure the insulation in place, use a couple of strips of adhesive tape to fasten the loose end of the superwool onto the previous layer.

FIXING THE FIRESTOP PLATES

When the chimney is installed through the wall/floor, the insulated gap should be closed off with the solid firestop plates on either side of the wall/floor.

Prior to fixing the firestop plate, we advise using a tailored piece of insulation blanket (the same size and shape as the firestop plate) and placing it between the firestop plate and the wall/floor to provide a sealing layer.

Important note for fixing the anchor bolts:

The drill holes for the anchor bolts and their fixings should be carried out in accordance with the manufacturer's instructions.

Each 2-piece firestop plate should be fixed to the wall/floor using eight anchor bolts. We recommend using:

- HILTI HST3 M10X80
- FISCHER FAZ II10/10.

Fire stop plate EI120

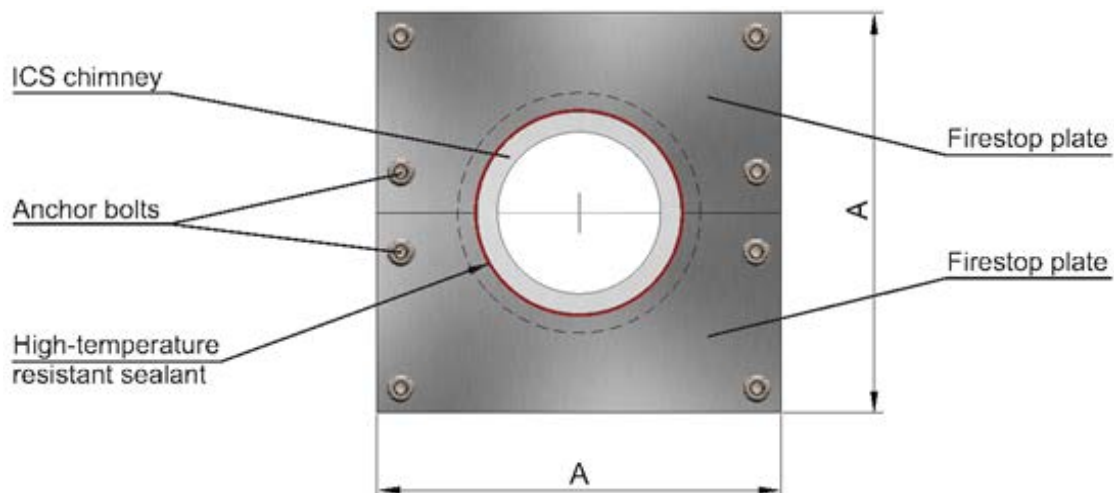

The fixing of the firestop plates can be alternatively carried out by means of threaded rods tightened from both sides with nuts. In this case, the drill holes for inserting the threaded rods should be drilled through the wall/floor.

The diameter of the opening in the firestop plate is app. 1,0 mm larger than the outer diameter of the chimney to allow for thermal expansion of the flue. The gap between the chimney's outer pipe and the firestop plate should be sealed with a high-temperature resistant sealant. We recommend the use of the following sealants:

- CASCO HEAT 1500 OR
- SIKASIL 670 F.

Before installing the firestop plate a patch of Superwool Plus blanket should be tailored according to the shape and size of the firestop plate and **installed** between the wall/floor and the firestop plate.

FIRE STOP PLATE (NON COMBUSTIBLE FLOOR/WALL)

This fire stop plate is used exclusively where the chimney passes through a non combustible floor / wall. The two halves of the plate are located around the chimney section and fastened to the floor using bolts or screws provided by others.

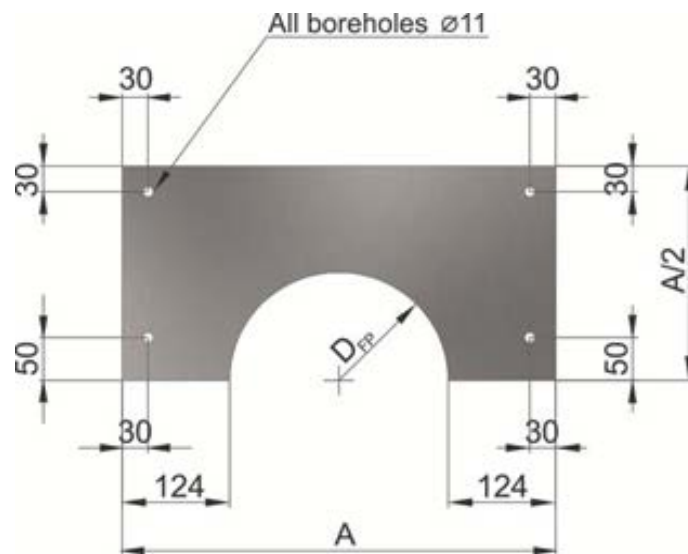

Sizes of firestop plates													
Ø ICS 25	80	100	130	150	180	200	230	250	300	350	400	450	500
Ø ICS 50					130	150	180	200	250	300	350	400	450
D FP	132	152	182	202	232	252	282	302	352	402	452	502	552
A	380	400	430	450	480	500	530	550	600	650	700	750	800

Support components

STRUCTURAL WALL BAND

The structural wall band is supplied in two parts, a stainless steel split band which fits tightly around the outside of the chimney and a stainless steel back bracket. The parts are joined together by means of the nuts and bolts provided. The use of the item maintains a fixed distance of 50mm from the outer casing of the chimney to the wall or fixing point. It can be used in combination with the structural wall band extension components to provide for adjustment to various distances from the wall.

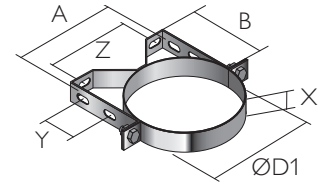

Structural Wall Band

1. Once the position of the support has been determined, secure the back bracket to the wall with a method of fixing to ensure adequate attachment and support.
2. The stainless steel split band is then positioned around the chimney section and secured with the nuts and bolts provided to the back bracket.
3. The wall bracket provides lateral stability only, it is NOT load bearing and is to be positioned at maximum 4 metre centres.

Structural wall band (50mm)

Int Ømm	80	100	130	150	180	200	250	300	350	400	450	500	600
---------	----	-----	-----	-----	-----	-----	-----	-----	-----	-----	-----	-----	-----

ICS25 Ext	130	150	180	200	230	250	300	350	400	450	500	550	650
ICS25 SAP	101263	101264	101265	101266	101267	101268	101269	101270	101271	101272	101273	101274	101275
A	138	158	188	208	238	258	308	358	412	462	512	562	662
B	115.6	125.6	140.6	150.6	165.6	175.6	200.6	225.2	250.2	275.2	300.3	325.3	375.3
D1	131.1	151.2	181.1	201.1	231.1	251.1	301.1	350.4	400.4	450.4	500.5	550.5	650.5
X	36	36	36	36	36	36	36	60	60	60	60	60	60
Y	55	55	55	55	55	55	85	125	145	145	145	145	145
Z	100	120	150	170	200	220	270	320	370	420	470	520	620
Weight (kg)	0.44	0.48	0.53	0.58	0.64	0.70	0.79	0.85	1.33	1.60	2.09	3.20	4.00

ICS50 Ext	180	200	230	250	280	300	350	400	450	500	550	600	700
ICS50 SAP	101265	101266	101267	101268	101402	101269	101270	101271	101272	101273	101274	133782	104430
A	188	208	238	258	288	308	358	412	462	512	562	612	712
B	140.6	150.6	165.6	175.6	190.6	200.6	225.2	250.2	275.2	300.3	325.3	350	400
D1	181.1	201.1	231.1	251.1	281.1	301.1	350.4	400.4	450.4	500.5	550.5	600.5	701
X	36	36	36	36	36	36	60	60	60	60	60	60	60
Y	55	55	55	55	85	85	125	145	145	145	145	145	145
Z	150	170	200	220	250	270	320	370	420	470	520	570	670
Weight (kg)	0.53	0.58	0.64	0.7	0.64	0.79	0.85	1.33	1.6	1.96	2.09	6.3	5.5

Support components

STRUCTURAL WALL BAND EXTENSIONS

Available in 3 different sizes. Type W1 gives adjustment of between 55-100mm from the wall. L1 gives adjustment of between 100-250mm from the wall and L2 gives adjustment of between 100-440mm from the wall.

1. Once the position of the support has been determined, secure the back bracket to the wall with a method of fixing to ensure adequate attachment and support.
2. Fasten the structural wall band to the extension brackets using the nuts and bolts provided.

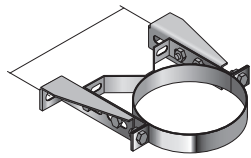

Structural Wall Band with
Type W1
Extension Assembly

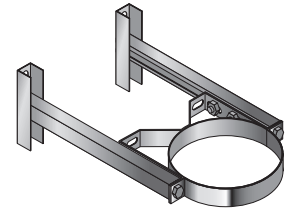

Structural Wall Band
with Types L1 & L2
Extension Assembly

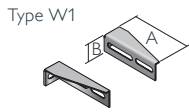

Wall fixing hole size
13mm dia

Structural wall band ext	
Type	W1
Adjustment	55-100
ICS SAP	101735
A	130
B	36
Weight (kg)	0.13

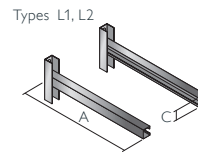

Wall fixing hole size
13mm dia

Structural wall band ext		
Type	L1	L2
Adjustment	100-250	100-440
ICS SAP	143846	143847
A	300	450
C	32	32
Weight (kg)	0.75	0.95

Support components

LOAD BEARING SUPPORTS

All wall supports and floor supports are designed to provide load bearing support for the chimney. They must be used in combination with the relevant lateral support components, wall bands, guy wire brackets or telescopic roof stays as appropriate. See p.39 for further information.

BASE SUPPORT PLATE WITH DRAIN

This component is used to support the chimney directly from the floor. It should be fastened securely to the floor using bolts or screws provided by others.

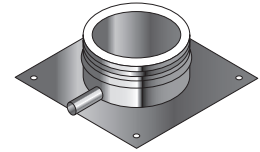

ADJUSTABLE TOP PLATE

Adjustable top plate and adjustable top plate with drain

These are designed to be used internally or externally to provide load bearing support for vertical chimney sections. The top plate can be used as an intermediate support as well as a base support in combination with a drain plug. The top plate with drain is used at the base of a vertical chimney to allow for drain off of condensate or rainwater from the stack. The turn up folds at the front and back of the plate allow for increased load bearing support, whilst allowing for the plate to slide along the cantilever supports and give positional adjustment.

On the standard top plate, the female socket beneath the plate should be pushed on to the preceding pipe length and secured in place using the locking band provided. The top plate is then attached to the side plates or the cantilever brackets using the bolts provided through the fixing slots in the top plate (see Fig. 1). The bolts should then be tightened firmly.

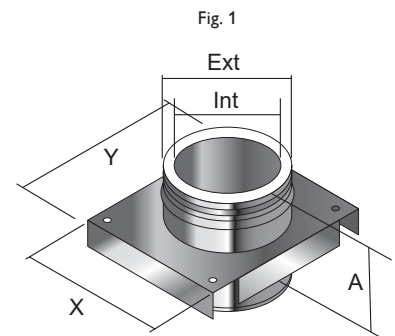

For maximum height of chimney see load bearing details, please refer to tables and diagrams on page 22.

Top Plate + locking band and gasket

Int Ømm	80	100	130	150	180	200	250	300	350	400	450	500	600
ICS25 Ext Ømm	130	150	180	200	230	250	300	350	400	450	500	550	650
ICS25 SAP code	113104	115159	115144	115158	115765	116059	116683	117198	117798	118177	118495	118717	113772
A	95	95	95	95	95	95	95	95	95	92	92	92	92
X	188	208	238	258	278	315	335	385	435	485	535	585	685
Y	255	275	305	325	355	383	403	453	503	553	603	653	753
Weight (kg)	1.65	2.07	2.69	3.11	3.73	4.15	5.19	6.22	7.26	8.07	9.08	10.09	12.10

ICS50 Ext Ømm	180	200	230	250	280	300	350	400	450	500	550	600	700
ICS50 SAP code	117214	116239	117059	117215	117538	117825	118208	118587	113621	119289	119288	119287	121052
A	95	95	95	95	95	95	95	95	95	92	92	92	92
X	238	258	278	285	315	335	385	435	485	535	585	635	735
Y	305	325	355	353	383	403	453	503	553	603	653	703	803
Weight (kg)	2.91	3.62	4.67	4.96	5.68	6.18	7.55	8.96	10.42	11.83	13.30	15.18	18.84

Support components

SIDE PLATES/CANTILEVER BRACKETS

Once the position of the support has been established in relation to the chimney route, secure the side plates or cantilever brackets to the wall using expansion bolts to ensure adequate attachment and support (see Fig. 2).

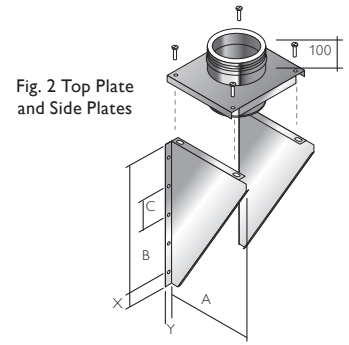

Wall support side plates													
Int Ømm	80	100	130	150	180	200	250	300	350	400	450	500	600
ICS25 Ext Ømm	130	150	180	200	230	250	300	350	400	450	500	550	650
ICS25 SAP code	101042	101043	101044	101045	101046	101047	101048	101049	101050	101051	101052	101053	101054
A	220	240	270	290	310	315	365	415	465	515	565	615	715
B	470	470	470	470	470	470	470	470	670	670	670	870	870
C	100	100	100	100	100	100	100	100	100	100	100	100	100
X	35	35	35	35	35	35	35	35	35	35	35	35	35
Y	28	28	28	28	28	28	28	28	28	28	28	28	28
Weight (kg)	2.2	2.39	2.85	3.14	3.32	3.54	3.72	4	5.4	7.58	8.2	11.2	19.14
ICS50 Ext Ømm	180	200	230	250	280	300	350	400	450	500	550	600	700
ICS50 SAP code	101044	101045	101046	101047	101339	101048	101049	101050	101051	101052	101053	104395	104396
A	270	290	310	315	345	365	415	465	515	565	615	665	765
B	470	470	470	470	470	470	470	670	670	670	870	870	870
C	100	100	100	100	100	100	100	100	100	100	100	100	100
X	35	35	35	35	35	35	35	35	35	35	35	35	35
Y	28	28	28	28	28	28	28	28	28	28	28	28	28
Weight (kg)	2.85	3.14	3.32	3.54	3.61	3.72	4	5.4	7.58	8.2	11.2	15.36	20.06

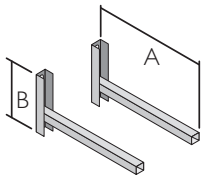

Wall fixing hole size 13mm dia

Type	325	475
A	325	475
B	242	242
Weight (kg)	1.24	1.54
ICS25 Int Ømm	80 - 150	80-300
ICS25 Ext Ømm	130 -200	130 - 350
ICS25 SAP code	101742	101743
ICS50 Int Ømm	80 - 100	80 - 250
ICS50 Ext Ømm	180 - 200	180 -350
ICS50 SAP Code	101742	101743

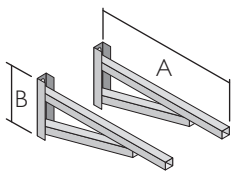

Wall fixing hole size 13mm dia

Type	570	720	820
A	570	720	820
B	330	330	380
Weight (kg)	2.23	2.46	2.76
ICS25 Int Ømm	80 - 500	80-600	80-600
ICS25 Ext Ømm	130 - 550	130 - 650	130 - 650
ICS25 SAP code	101744	101746	101747
ICS50 Int Ømm	80 - 450	80 - 500	80 - 600
ICS50 Ext Ømm	180 - 550	180 - 600	180 - 700
ICS50 SAP Code	101744	101746	101747

Support components

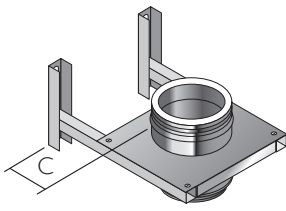

Cantilever Support

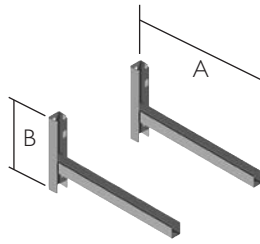

Cantilever Brackets

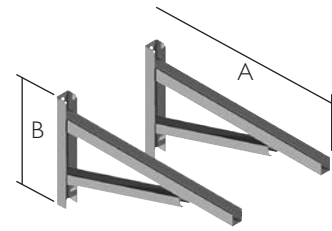

Cantilever Bracket

Cantilever Support Adjustment ICS25

Int Diam	80	100	130	150	180	200	250	300	350	400	450	500	600
Ext Diam	130	150	180	200	230	250	300	350	400	450	500	550	650
C max (mm)													
Type 325	184	164	134	114	84	64							
Type 475	334	314	284	264	234	214	164	114	64				
Type 570	429	409	379	359	329	309	259	209	159	109	59		
Type 720	579	559	529	509	479	459	409	359	309	259	209	159	109
Type 820	679	659	629	609	579	559	509	459	409	359	309	259	209
C min (mm)													
Type 325										50	50	50	50
Type 475	50	50	50	50	50	50	50	50	50	50	50	50	50
Type 570	50	50	50	50	50	50	50	50	50	50	50	50	50
Type 720	50	50	50	50	50	50	50	50	50	50	50	50	50
Type 820	50	50	50	50	50	50	50	50	50	50	50	50	50

Cantilever Support Adjustment ICS50

Int Diam	80	100	130	150	180	200	250	300	350	400	450	500	600
Ext Diam	80	200	230	250	280	300	350	400	450	500	550	600	700
C max (mm)													
Type 325	134	114	84	64	34	14							
Type 475	284	264	234	214	184	164	114	64	14				
Type 570	379	359	329	309	279	259	209	159	109	59			
Type 720	529	509	479	459	429	409	359	309	259	209	159	109	59
Type 820	629	609	579	559	529	509	459	409	359	309	259	209	159
C min (mm)													
Type 325										50	50	50	50
Type 475	50	50	50	50	50	50	50	50	50	50	50	50	50
Type 570	50	50	50	50	50	50	50	50	50	50	50	50	50
Type 720	50	50	50	50	50	50	50	50	50	50	50	50	50
Type 820	50	50	50	50	50	50	50	50	50	50	50	50	50

Support components

GUY WIRE BRACKET

This component should be used to secure unsupported chimney sections above roof level. Guy wires or preferably rigid stays (supplied by others) must be fixed to the bracket and secured to suitable anchorage points to ensure that the chimney sections are stable.

A maximum chimney height of 1.5 metres from the last support, or from the roof is permitted. Additional height requirements MUST be supported at 1.5 metre intervals using the guy wire bracket as specified above, or by using telescopic roof stays.

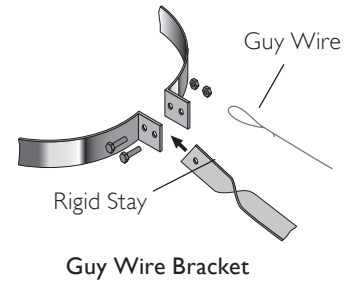
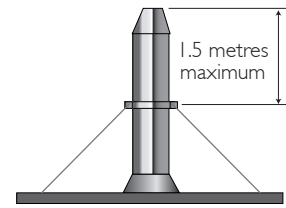

CEILING HANGER

This accessory is designed to support 'horizontal' runs of the chimney from the roof or ceiling. Please note that when used in combination with a condensing appliance, this 'horizontal' section must have a fall of minimum 3° on it to allow for condensate to drain back to a suitable drain point and to avoid pooling of condensate, which would damage the gaskets. Schiedel provides the split band and the installer will provide the screwed rod and fittings.

1. Position the split band around the chimney section and fasten using the nuts and bolts provided. The second bolt hole on the arms of the band is to allow for connection of the screwed rod, which will be provided by the installer.
2. Maximum support spacing for the ceiling hanger is to be no more than 1.5 metres between centres.

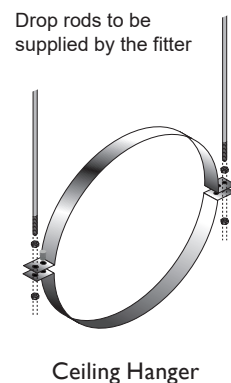

Support components

WALL SLEEVE (90° & 45° VARIANTS)

Wall sleeves must be used to protect the building where the chimney passes through a wall (see Fig. 2 & 3). The 90° version is supplied as a straight length whereas the 45° version is mitred at 45 degrees on one end. The sleeve should be cut down to the correct length on site to fit flush with the wall (see Fig. 1 & 2). The sleeve should be adequately weatherproofed, using a good quality building mastic and rope fibre.

TWO PIECE TRIM COLLAR (90° & 45° VARIANTS)

Two piece trim collars are fitted around the ICS pipe where it protrudes through both the inside and the outside of the wall (see Fig. 1 & 2). They should be fastened to the wall using an adequate method of fixing. The trim collars should be adequately weatherproofed back to the wall and around the chimney, using a good quality building mastic or equivalent.

ANGLED FLASHING

Manufactured in sheet aluminium for use on pitched roofs. The base of the flashing should be nailed or screw fixed to the roof batons prior to tiling. The front edge of the flashing should be hooked to the underside of the batons to prevent lifting. This component should be sealed with the mastic sealant provided and MUST be used in conjunction with the storm collar supplied.

FLAT FLASHING

Manufactured in sheet aluminium for use on flat roofs the base of the flashing should be covered by the roofing felt and then sealed. This component should be sealed with the mastic sealant provided and MUST be used in conjunction with the storm collar supplied.

STORM COLLAR

The storm collar should be sealed to the outer casing of the flue immediately above the flashing with the mastic sealant provided.

UNIFLASH

This item, which is manufactured with a malleable base and a silicone cone is used to provide a water tight flashing around the chimney as it passes through a roof pitched between 0-45 degrees. The cone is marked with pipe diameter sizes.

Cut the cone to suit the correct diameter of chimney.

Slide the flashing down over the top of the pipe and then form the base to the shape of the roof surface. Seal as required.

Ext Ø	80-200	150-300	250-450
A	500	685	800

TERMINALS

Terminals are supplied complete with a locking band. Once the terminal has been pushed into place, the adjustment bolt on the locking band clip should be tightened to ensure that the terminal is properly secured to the previous pipe.

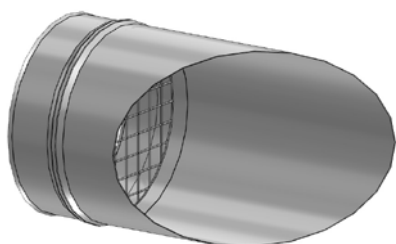

Horizontal terminal

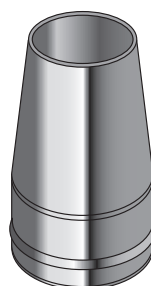

Tapered Terminal

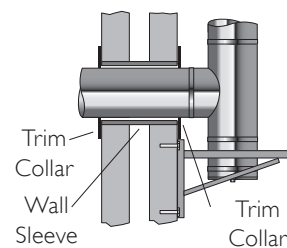

Fig. 1

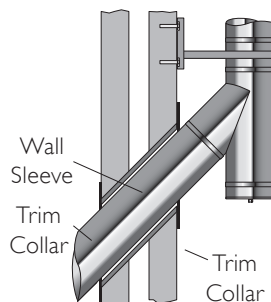
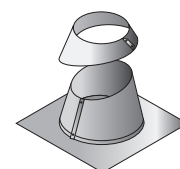
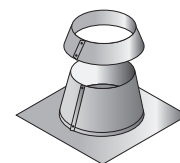

Fig. 2



Angled flashing



Flat flashing



Storm Collar

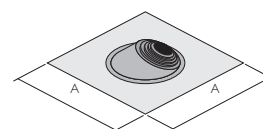

Uniflash

Typical external installations

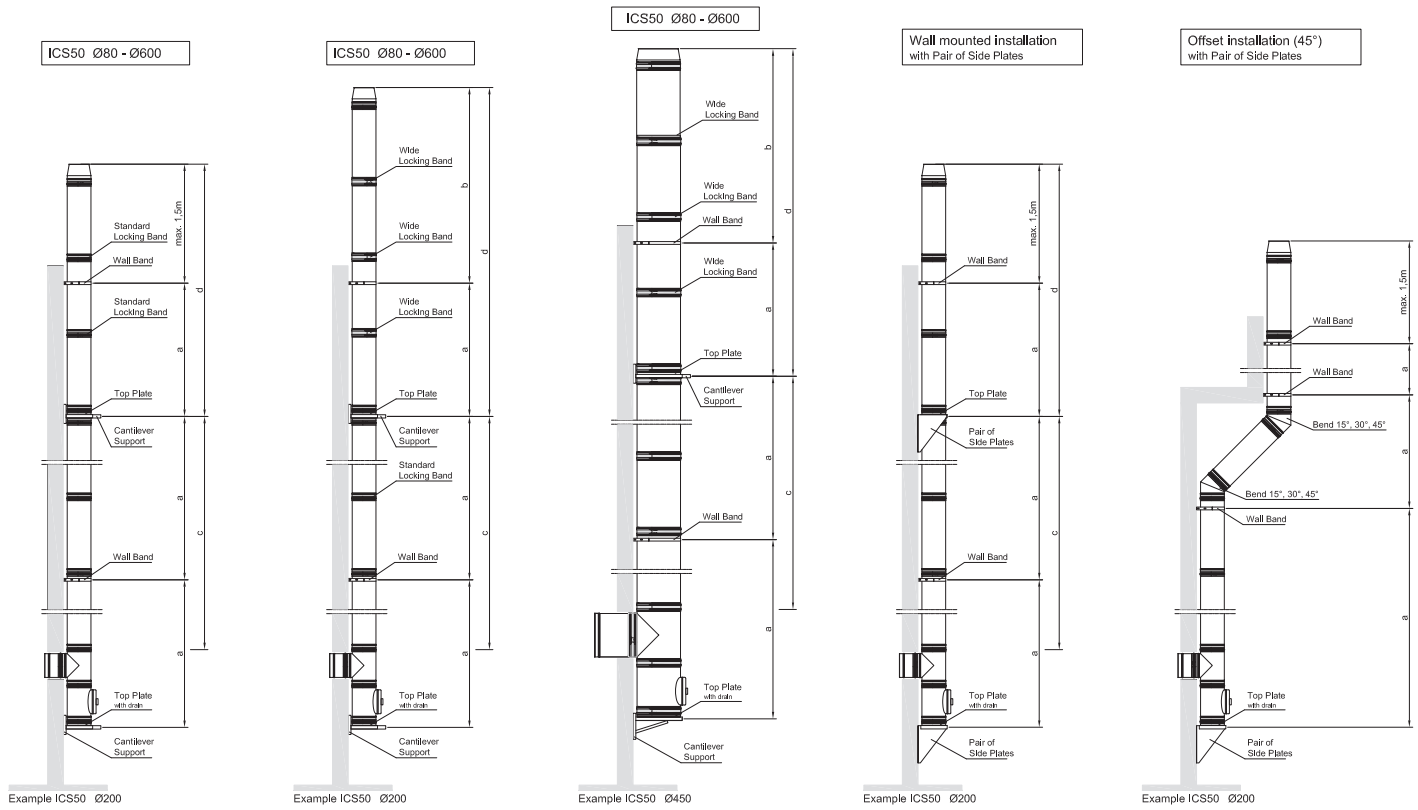

Max distance between supports ICS25 5000

Int diam (mm)	a	b	c	d
80	4	3	15	15
100	4	3	15	15
130	4	3	15	15
150	4	3	15	15
180	4	3	15	15
200	4	3	15	15
230	4	3	15	15
250	4	3	15	15
300	4	3	15	15
350	3	3	8	12
400	3	3	8	12
450	3	3	8	12
500	3	3	8	12
600	3	3	6	8

Max distance between supports ICS50 5000

Int diam (mm)	a	b	c	d
80	4	3	10	10
100	4	3	10	10
130	4	3	10	10
150	4	3	10	10
180	4	3	10	10
200	4	3	10	10
230	4	3	10	10
250	4	3	10	10
300	4	3	10	10
350	3	3	6	8
400	3	3	6	8
450	3	3	6	8
500	3	3	6	8
600	3	3	4	6

Load bearing information

ICS25 5000

Int Ø mm	80	100	130	150	180	200	230	250	300	350	400	450	500	600
Base Drain Section	22	22	22	18	18	18	18	18	18	12	12	12	10	10
Top Plate with drain	15	15	15	15	15	15	15	15	15	12	12	12	10	8
Top Plate + Locking band	15	15	15	15	15	15	15	15	15	12	12	12	10	8
Pair of Side Plates (See Diagram A)	15	15	15	15	15	15	15	15	15	12	12	12	10	8
Pair of Side Plates (See Diagram B)	10	10	10	10	10	10	10	10	10	10	10	10	6	6
Cantilever Support	15	15	15	15	15	15	15	15	15	12	12	12	10	8
Ceiling Hanger	1.5	1.5	1.5	1.5	1.5	1.5	1.5	1.5	1.5	1.5	1.5	1.5	1.5	1.5
Wall band 50mm	3	3	3	3	3	3	3	3	3	3	3	3	3	3
Adjustable Wall band 75-300mm	3	3	3	3	3	3	3	3	3	3	3	3	3	3
Heavy Duty Wall Band	4	4	4	4	4	4	4	4	4	3	3	3	3	3
Extension for Heavy Duty Wall	4	4	4	4	4	4	4	4	4	3	3	3	3	3
Guy Wire Bracket	1.5	1.5	1.5	1.5	1.5	1.5	1.5	1.5	1.5	1.5	1.5	1.5	1.5	1.5
90° Tee + Locking band	22	22	22	18	18	18	18	18	18	6	6	6	6	4
135° Tee + Locking band	15	15	15	10	10	10	10	10	10	3	3	3	3	2
Inspection Tee (Round)	22	22	22	18	18	18	18	18	18	6	6	6	6	4

ICS50 5000

Int Ø mm	80	100	130	150	180	200	230	250	300	350	400	450	500	600
Base Drain Section	10	10	10	10	10	10	10	10	10	8	8	8	7	6
Top Plate with drain	10	10	10	10	10	10	10	10	10	8	8	8	7	6
Top Plate + Locking band	10	10	10	10	10	10	10	10	10	8	8	8	7	6
Pair of Side Plates (See Diagram A)	10	10	10	10	10	10	10	10	10	8	8	8	7	6
Pair of Side Plates (See Diagram B)	7	7	7	7	7	7	7	7	7	7	7	7	4	4
Cantilever Support	15	15	15	15	15	15	15	15	15	12	12	12	10	10
Ceiling Hanger	1.5	1.5	1.5	1.5	1.5	1.5	1.5	1.5	1.5	1.5	1.5	1.5	1.5	1.5
Heavy Duty Wall Band	4	4	4	4	4	4	4	4	4	3	3	3	3	3
Extension for Heavy Duty Wall	4	4	4	4	4	4	4	4	4	3	3	3	3	3
Guy Wire Bracket	1.5	1.5	1.5	1.5	1.5	1.5	1.5	1.5	1.5	1.5	1.5	1.5	1.5	1.5
90° Tee + Locking band	15	15	15	12	12	12	12	12	12	4	4	4	4	2
135° Tee + Locking band	10	10	10	7	7	7	7	7	7	2	2	2	2	1
Inspection Tee (Round)	22	22	22	18	18	18	18	18	18	6	6	6	6	4

DIAGRAM A

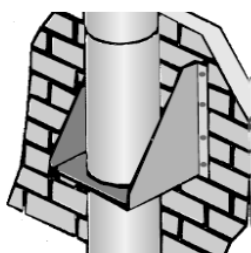
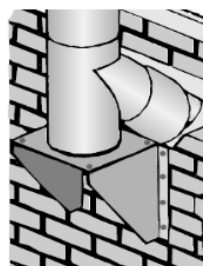

DIAGRAM B



Component weights

Approximate weights of finished pipe in kg - ICS25 lengths				
Int Ømm	1000	500	250	200
80	3.99	1.98	0.97	0.77
100	4.73	2.34	1.15	0.91
130	5.84	2.89	1.42	1.12
150	6.58	3.26	1.59	1.26
180	7.69	3.80	1.86	1.47
200	8.43	4.17	2.04	1.61
250	10.28	5.08	2.49	1.97
300	12.08	5.97	2.92	2.31
350	13.96	6.90	3.37	2.67
400	15.81	7.82	3.82	3.02
450	19.10	9.42	4.59	4.79
500	21.10	10.41	5.07	5.25
600	25.09	12.38	6.01	6.59

Approximate weights of finished pipe in kg - ICS50 lengths				
Int Ømm	1000	500	250	200
80	5.92	2.96	1.48	1.18
100	7.10	3.55	1.78	1.42
130	9.03	4.49	2.15	1.92
150	10.04	4.94	2.40	2.16
180	11.55	6.17	2.76	2.45
200	12.54	6.50	3.00	2.65
250	15.49	7.64	3.67	3.13
300	18.02	8.89	4.30	3.63
350	20.33	10.06	4.88	4.12
400	23.03	11.90	6.09	4.49
450	26.12	13.24	6.77	4.97
500	28.69	15.30	7.44	5.45
600	36.13	17.82	9.01	6.41

Useful guides

DOWNLOADS SPECIALIST CENTRE

We have a comprehensive range of CAD cells, typical installations using Isokern Pumice components and other diagrams, which are ideal resources for architects and builders when designing a chimney system for a new build or renovation

Visit our website and head over to the SPECIALIST CENTRE which can be found under the SCHIEDEL WORLD menu, or contact us and we will send a USB stick with all the relevant information and downloads on.

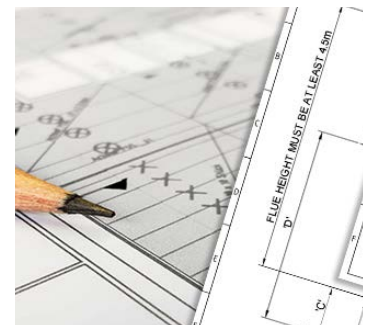

SCHIEDEL

Schiedel Chimney Systems Ltd.
Crowther Estate
Washington
Tyne & Wear NE38 0AQ
Tel. +44 (0)191 416 1150

sales.uk@schiedel.com | www.schiedel.com/uk

A **standard**
INDUSTRIES COMPANY