



SCHIEDEL

US Flue System

Concentric Flue System suitable for high temperature, non-condensing applications with flue gases in negative pressure.

System Description

The **US** system is a modular concentric balanced flue system, made of stainless steel which combines air inlet and flue. **US** is suitable for high temperature, non-condensing applications with flue gases in negative pressure. It can be applied on all types of balanced flue gas-fired stoves (class C11 and (231).

Applications

Concentric flue system for balanced flue gas-fired stoves (class Eli and C31)

Advantages

- Appliance adaptors manufactured on specification
- Both wall and roof terminals available
- Easy assembly with lightweight elements
- Wide product range offers solutions for virtually all situations
- Tested in combination with many appliances according to EN 613
- Also available in black

- A. Maximum supportable height above Tee piece when chimney is supported by wall support at base.
- B. Maximum supportable height that can be borne by wall support.
- C. Maximum distance between lateral supports i.e. wall bands and wall supports.
- D. Maximum allowable free standing height above last support.

For non-vertical parts of flue system the maximum distance between two wall bands i.e. brackets is 2,5 m

Important: the product with the lowest load bearing capacity determines the maximum supported height.

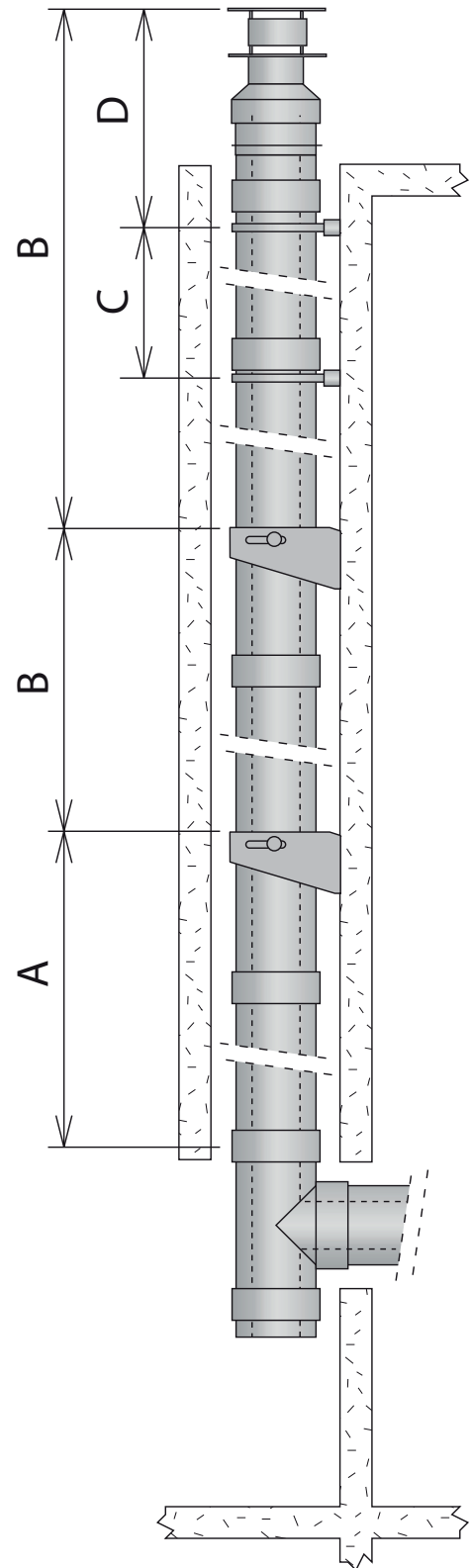

Technical characteristics

Technical characteristics		
Application		Balanced flue
Operating mode		Dry
Pressure		Negative pressure
Max. working pressure		0 Pa
Operating temperature		600°O
Max. temperature allowed		600°C
Inner wall	material	AISI 304/EN 1.4301
	thickness	0.4 mm
Outer wall	material	AISI 304/EN 1.4301
	thickness	0.4 mm
Fuel type		Gas
Chimney diameter		
Inner diameter (mm)	100	130
Outer diameter (mm)	150	200
Cross section (cm ²)	79	133
Weight (±kg/m)	2.5	4.0
CE approved		
EN 1856-1: T450 N1 D V2 L20040 050, T450 N1 D V2 L20040 050		
EN 1856-2: T450 N1 D V2 L20040 050, T450 N1 D V2 L20040 050		

Mounting heights and distances			
Ø (mm)		100	130
A (m)	UST 90	30	30
	USOL	30	30
B (m)	USMO	30	30
	USDQ	5	5
C (m)	USAH*	4	4
	USMB*	4	4
	USEB	2	2
	USDQ	1	4
D (m)	USMB*	2	2
	USEB	1	1
	USSAN*	2	2
	USSAN 1*	2	2
	USDQ*	2	2

* Installed with USKB or USKBS

Horizontal Terminals

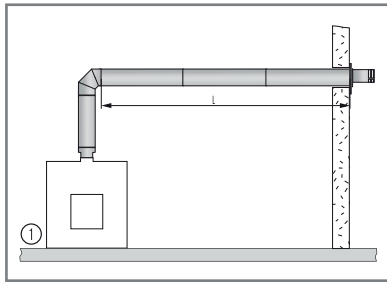

USDHC1/2/5-10

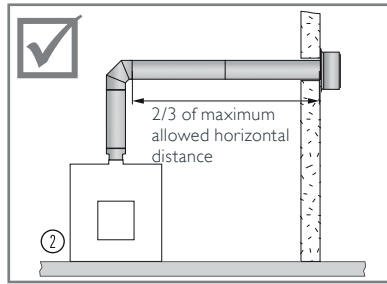

USDHC3-10

- 1/3/5 are approved appliance-flue combinations
- 2 Indication of maximum horizontal length when using the USDHC3-10

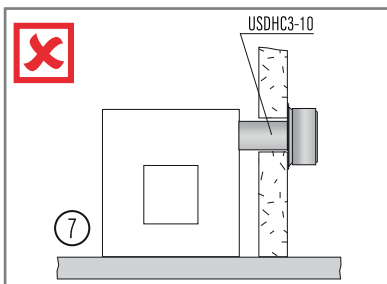
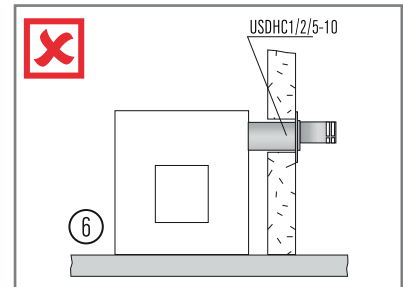
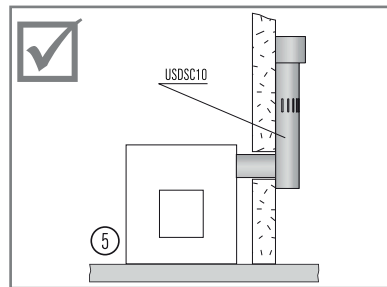
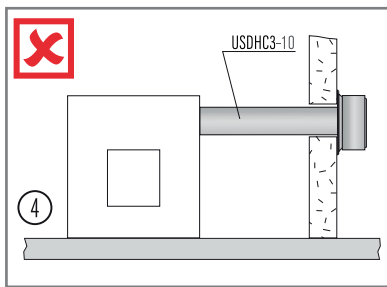
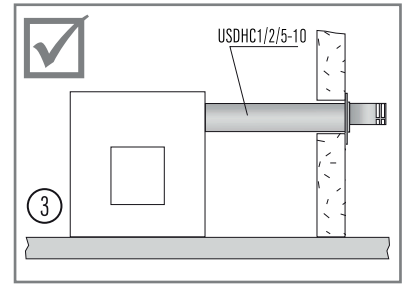

- 4/6/7 not to apply, unless expressly permitted by the appliance manufacturer

Design-chimneys

We provide Design-chimneys in our product groups AT, MF, EN, US and UE. To give you an outer wall that is completely smooth and flat, without locking bands, etc. And at no extra cost!

These design parts are ideal for visible chimneys and only to be used vertically and not freestanding.



COLOUR RANGE



- Black Matte
- Heat resistant stove paint
- Ontop code 910



- Anthracite Matte
- Heat resistant stove paint
- Ontop code 930



- Grey Matte
- Heat resistant stove paint
- Ontop code 970

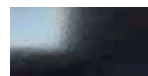

- Grey half shine (for Al and MF)
- Powder coated
- RAUZI



- Olive black half shine (for Al and MF)
- Powder coated
- Cewetherm 300

Other colours on request:

- RAL-code
- Powder coating | wet paint
- Shine | half shine | matt

Design-Chimney Adaptors

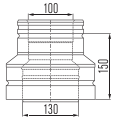

Reducer	
ID	100/130
Old Code	USVK1013
SAP Code	163859

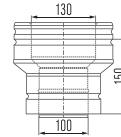

Increaser	
ID	100/130
Old Code	USVG1013
SAP Code	163858

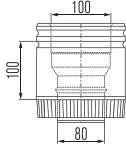

Adaptor DRU	
ID	80/100
Old Code	USAD10
SAP Code	163720

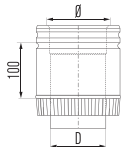

Adaptor				
Length mm	100	100	940	940
Ø	100	130	100	130
D	99	129	99	129
Old Code	USA10	USA13	USAA10	USAA13
SAP Code	163698	163699	163706	163707

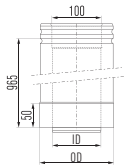

Adaptor KAL-FIRE				
Length mm	965	965	965	965
ID	100	100	150	149
OD	153	150	203	200
Old Code	USAAK 10	USAAK2 10	USAAK 13	USAAK2 13
SAP Code	163714	163716	163715	163717

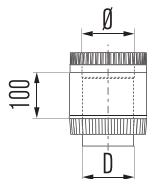

Adaptor Design		
Ø	100	130
D	99	129
Old Code	USDA10	USDA13
SAP Code	163762	163763

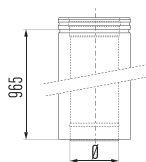

Adaptor US Design - US 100 cm		
Ø	100	130
Old Code	USDO10	USDO13
SAP Code	163801	163802

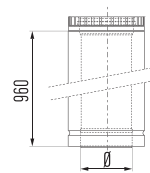

Adaptor US-US Design - US 100 cm		
Ø	100	130
Old Code	USDOC10	USDOC13
SAP Code	163803	163804

Pipes

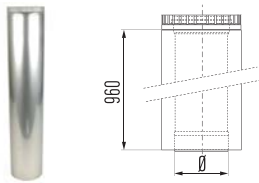

Length 100 cm Design		
Ø	100	130
Old Code	USD10010	USD10013
SAP Code	163740	163741

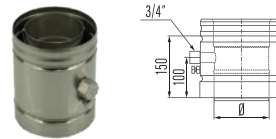

Probe length		
Ø	100	130
Old Code	USEM10	USEM13
SAP Code	163830	163831

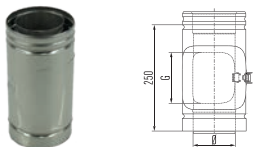

Inspection element		
Ø	100	130
G	100	130
Old Code	USI10	USI13
SAP Code	163832	163833



Adjustable length		
Ø	100	130
D	152	202
d1	97	127
Old Code	USPP10	USPP13
SAP Code	163845	163846

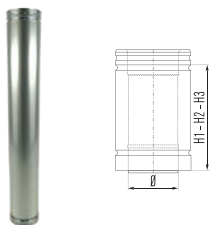

Length		
Ø	100	130
H1	965	965
Old Code	US10010	US10013
SAP Code	163689	163690
H2	460	460
Old Code	US5010	US5013
SAP Code	163694	163695
H3	220	220
Old Code	US2510	US2513
SAP Code	163691	163692

Bends / Tees

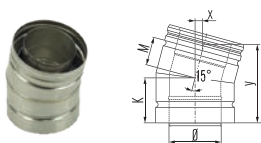

Bend 15°		
Ø	100	130
K	85	95
M	55	65
X	15	15
Y	140	165
Old Code	USB1510	USB1513
SAP Code	163723	163724



Bend 30°		
Ø	100	130
K	85	95
M	55	65
X	30	35
Y	135	150
Old Code	USB3010	USB3013
SAP Code	163725	163726

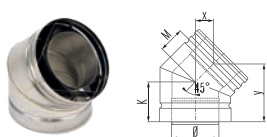

Bend 45°		
Ø	100	130
K	85	95
M	55	65
X	35	45
Y	125	140
Old Code	USB4510	USB4513
SAP Code	163727	163728

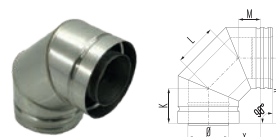

Bend 90°		
OD	100	130
Old Code	USB9010	USB9013
SAP Code	163729	163730

Bends / Tees

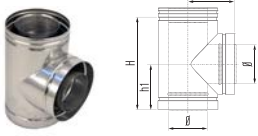

Tee-piece 90°		
ID		
OD	100	130
H	225	305
h1	125	150
x	115	155
Old Code	UST9010	UST9013
SAP Code	163856	163857

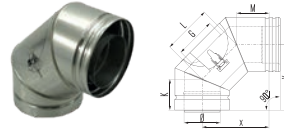

Bend 90° with inspection cover		
OD	100	130
K	85	95
L	135	155
M	90	65
G	100	130
X	185	175
Y	180	205
Old Code	USB110	USB113
SAP Code	163731	163732

Trim Collars

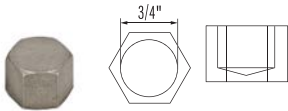

Cap		
ID		
OD		
Old Code		USE0304
SAP Code		

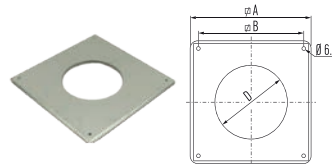

Wall cover large		
OD	100	130
D	153	203
A	300	350
B	260	310
Old Code	USMPG10	USMPG13
SAP Code	165081	165082

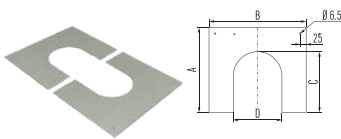

Cover plates (pair)		
OD	100	130
A	275	300
B	350	400
C	175	200
D	151	201
Old Code	USCP10	USCP13
SAP Code	163733	165075

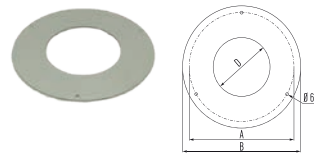

Rosette smooth		
OD	100	130
D	154	204
A	270	320
B	290	340
Old Code	USR10	USR13
SAP Code	163847	165087

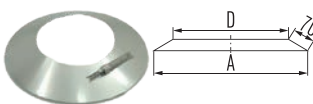

Storm collar		
OD	100	130
D	150	200
A	275	325
Old Code	USSR10	USSR13
SAP Code	163854	163855

Support Components

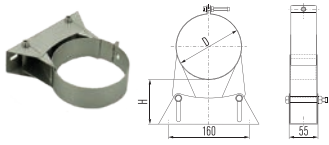

Wall band adjustable		
OD	100	130
D	150	200
H	50-90	50-90
Old Code	USMB10	USMB13
SAP Code	163843	163844

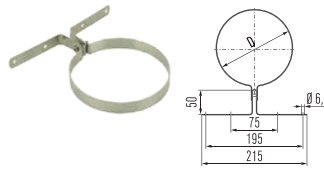

Mounting band		
OD	100	130
D	150	200
Old Code	USEB10	USEB13
SAP Code	163828	163829

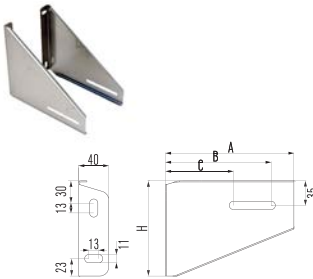

	Support light (pair) for USMO			
	1 (50-90mm)		2 (90-200mm)	
Ø	100	130	100	130
A	220	220	315	335
B	190	190	285	305
C	125	125	165	180
H	170	170	255	275
Old Code	USOL 1		USOL 2	
SAP Code	165083	165084	165085	165086

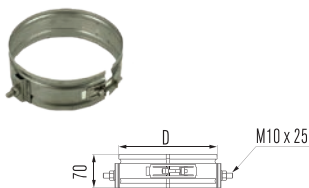

Band for wall support		
Ø	100	130
D	150	200
Old Code	USMB10	USMB13
SAP Code	163843	163844

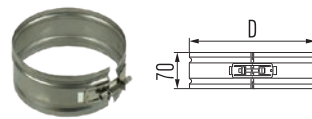

Locking band		
Ø	100	130
D	150	200
Old Code	USKB10	USKB13
SAP Code	163834	163835

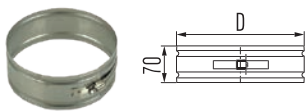

Locking band with screw fitting		
Ø	100	130
D	150	200
Old Code	USKBS10	USKBS13
SAP Code	163836	163837

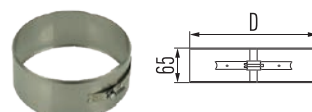

Protection band		
Ø	100	130
D	150	200
Old Code	USAB10	USAB13
SAP Code	163718	163719

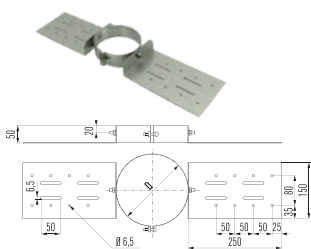

Roof support		
Ø	100	130
D	150	200
Old Code	USDQ10	USDQ13
SAP Code	163816	165077

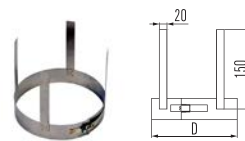

Positioner		
Ø	100	130
D	150	200
Old Code	USAH10	USAH13
SAP Code	165073	165073

Flashings

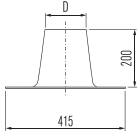

Flat roof flashing aluminium		
Ø	100	130
D	155	205
Old Code	USDPAL10	USDPAL13
SAP Code	163807	163808

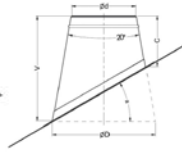

36°-45° Roof flashing - Wakaflex / matt cone		
Int	100	130
Ø d mm	165	200
Ø D mm	320	367
A	767	821
B	675	715
SAP Matt Cone	175278	175279

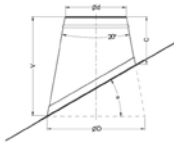

26°-35° Roof flashing - Wakaflex / matt cone		
Int	100	130
Ø d mm	165	200
Ø D mm	292	335
A	709	754
B	664	703
SAP Matt Cone	175269	175270

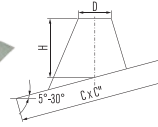
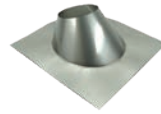

Slope roof flashing 5°-30°		
D	155	205
C	520	575
C''	500	550
H	155	160
Old Code	USDH10	USDH13
SAP Code	163788	165076

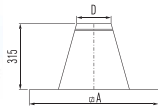

Flat roof flashing		
OD	100	130
D	160	210
A	440	490
Old Code	USDP10	USDP13
SAP Code	163805	163806

Terminals

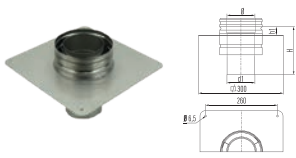

Renovation set top		
Ø	100	130
d1	99	129
H	175	420
h1	38	140
Old Code	USSAN110	USSAN113
SAP Code	163850	163851

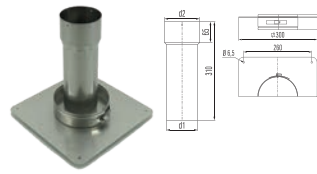

Renovation set bottom		
Ø	100	130
d1	97	127
d2	109	139
Old Code	USSAN210	USSAN213
SAP Code	163852	163853

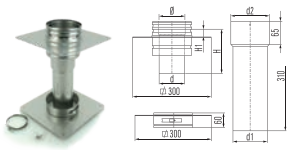

Renovation set		
Ø	100	130
d	99	129
d1	97	127
d2	109	139
H	175	420
H1	30	140
Old Code	USSAN10	USSAN13
SAP Code	163848	163849



Vertical terminal + USKB	
Ø	
Old Code	USDVC210
SAP Code	163826

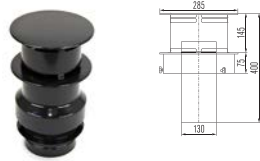

Vertical terminal + USKB	
Old Code	USDVC13
SAP Code	163825

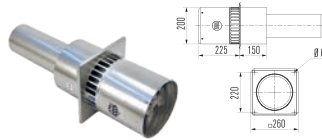

Wallstream: chimney fan wall 130/200	
Old Code	USWSTREAM
SAP Code	163860
Only available for OEM.	

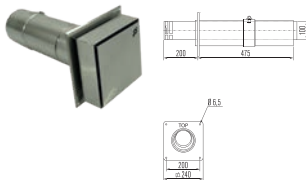

Horizontal terminal eccentric with small wall cover + USAB		
Old Code	USDHC110	USDHC113
SAP Code	163790	163791

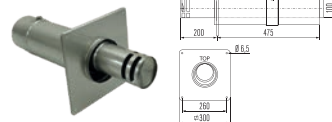

Horizontal terminal eccentric with large wall cover + USAB	
Old Code	USDHC210
SAP Code	163793

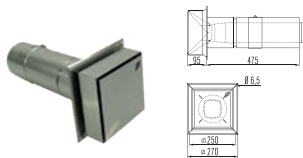

Horizontal terminal + USAB	
Old Code	USDHC310
SAP Code	163796

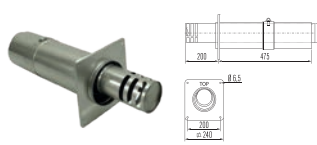

Horizontal terminal eccentric + USAB	
Old Code	USDHC510
SAP Code	163799

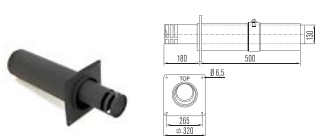

Horizontal terminal eccentric with small wall cover + USAB	
Old Code	USDHC113
SAP Code	163791

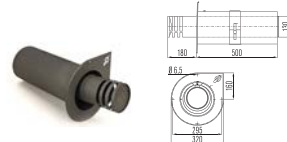

Horizontal terminal "rain-drop" + USAB colour: cast iron grey	
Old Code	USDHC410
SAP Code	163798

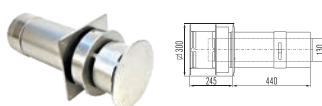

Horizontal terminal + USAB	
Old Code	USDHC13
SAP Code	163789

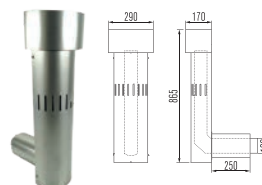

Terminal "snorkel"	
Old Code	USDSC10
SAP Code	163824

Typical Installation

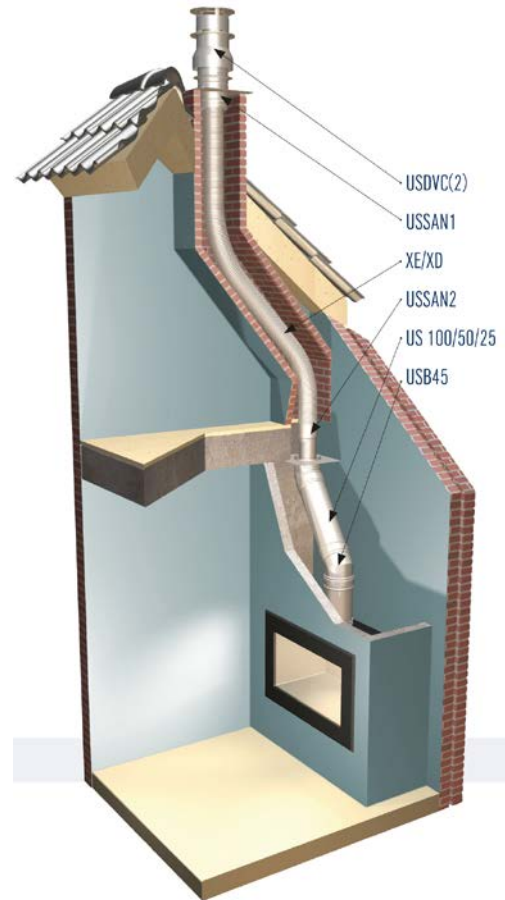
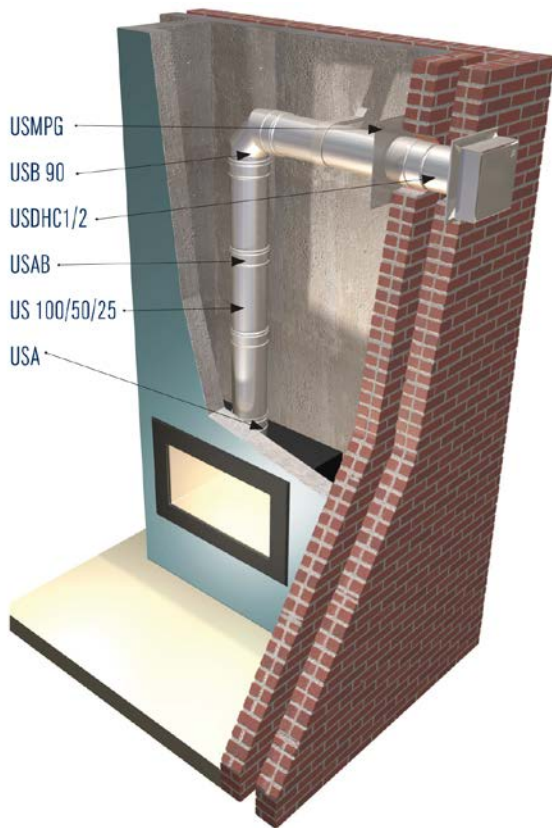

USDHC1 10



USDHC1 10



USDHC3 10

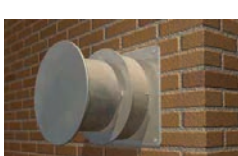

USDHC13



USDHC4 13



USDHC5 10

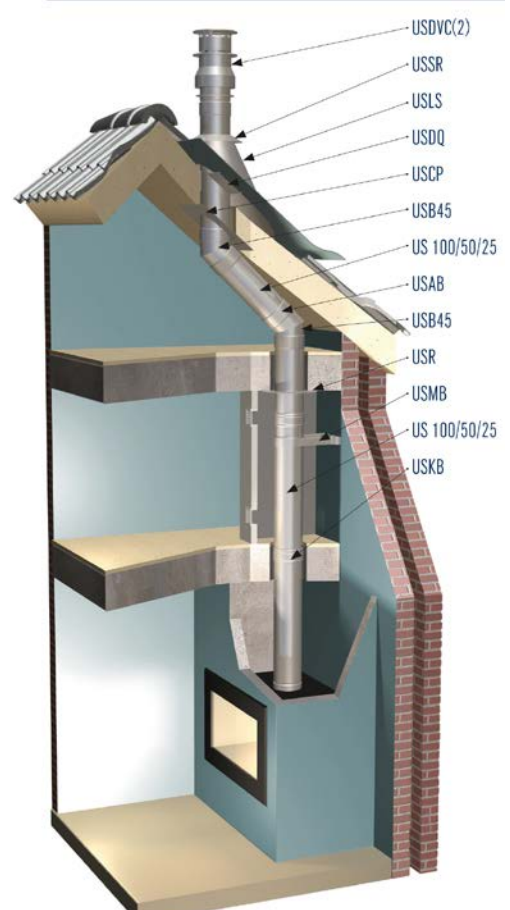

SCHIEDEL

Schiedel Chimney Systems
Crowther Estate
Washington
Tyne & Wear NE38 0AQ
Tel. +44 (0)191 416 1150
Fax. +44 (0)191 415 1263

sales.uk@schiedel.com

SCHIEDEL INSTALLER REWARDS

Exciting news from Schiedel Chimney Systems!
Whenever you register an installation with our
easy to use, online guarantee registration portal,
you will now accrue points based on the number
of installations and installation type to redeem for
Love2Shop vouchers!



Follow us on Social Media @SchiedelUK



A standard
INDUSTRIES COMPANY