



SCHIEDEL

XD Flue Liner

316L & 904L stainless steel
flexible flue liner & accessories



www.schiedel.com/uk

SAP 940003653 - Updated 28 November 2023

Flexible Flue Liner

The XD system is a single strip, smooth bore flexible flue system made of stainless steel.

XD is suitable for both high and low temperatures, non-condensing and condensing applications with flue gases in positive and negative pressure conditions.

Therefore the system is suited for a wide range of renovation situations to line an existing chimney.

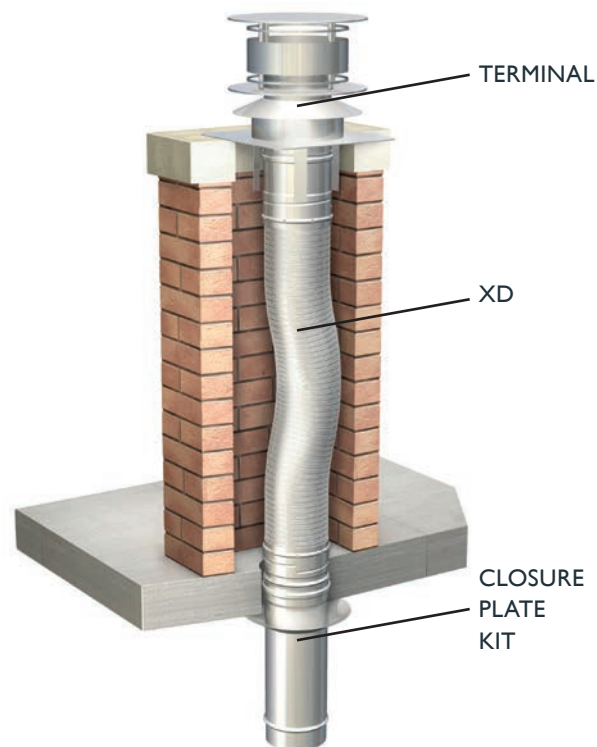

Applications

- Chimney renovation

Advantages

- Dimensional stability, even after multiple bending
- Marked every single metre
- Manufactured from austenitic stainless steel
- Connects with Metaloterm range

Technical characteristics		
Application		Flue system/connecting flue/renovation
Operating mode		Dry/wet
Pressure		Negative/positive pressure
Max. working pressure		200 Pa
Operating temperature		200°C positive pressure 600°C negative pressure
Max. temperature allowed		1000°C (max 30 min)
	material	AISI 316L/EN 1.4404 AISI 904L/EN 1.4539
	thickness	0.1 mm
Fuel type		Oil/Gas/Wood/Pellets Normal (Wood)

Packs



XD PACK 316L XD flexible system				
Ø	125	150	180	200
H1	600	600	800	800
5m Pack	168635	168636	168637	168638
6m Pack	168639	168640	168641	168642
7m Pack	168643	168644	168645	168646
8m Pack	168647	168648	168649	168650
9m Pack	168651	168652	168653	168654
10m Pack	168655	168656	168657	168658
11 m Pack	168659	168660	168661	168662
12m Pack	168663	168664	168665	168666



XD PACK 904L XD flexible system				
Ø	125	150	180	200
H1	600	600	800	800
5m Pack	168673	168674	168675	168676
6m Pack	168677	168678	168679	168680
7m Pack	168681	168682	168683	168684
8m Pack	168685	168686	168687	168688
9m Pack	168689	168690	168691	168692
10m Pack	168693	168694	168695	168696
11 m Pack	168697	168698	168699	168700
12m Pack	168701	168702	168703	168704

Adaptors



Adaptor Me - Flexible				
Ø	125	150	180	200
Ø Flex	125	150	180	200
Ø Nom SW	125	150	180	200
SAP Code	168830	168831	168832	168833



Adaptor Flexible - Me				
Ø	125	150	180	200
Ø Flex	125	150	180	200
Ø Nom SW	125	150	180	200
SAP Code	168834	168835	168836	168837

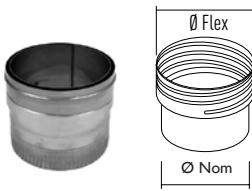

Adaptor Adaptor En - Flexible				
Ø	125	150	180	200
Ø Flex	125	150	180	200
Ø Nom SW	125	150	180	200
SAP Code	168838	168839	168840	168841



Increaser Eccentric Plain End To Xd				
Ø				125/150
Ø Flex				150
Ø Nom SW				125
SAP Code				168859

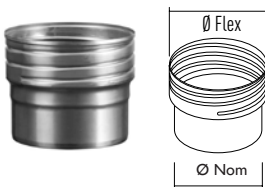

Adaptor Vitreous to XD					
Ø	122/125	122/150	148/150	178/180	198/200
Ø Flex	125	150	150	180	200
Ø Nom SW	122	122	148	178	198
SAP Code	168842	168843	168844	168845	169056

Adaptors

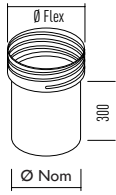

Extended Adaptor Vitrous to XD			
Ø	122/125	122/150	148/150
Ø Flex	125	150	150
Ø Nom SW	122	122	148
SAP Code	168846	168847	168848

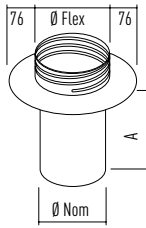

Closure Plate Adaptor Kit Fixed Plate Vit to XD			
Ø	122/125	122/150	148/150
Ø Flex	125	150	150
Ø Nom SW	122	122	148
A			200
SAP Code	168849	168850	168851

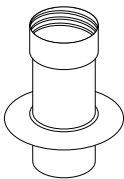

Adjustable Closure Plate Vit to XD			
Ø	125/125	125/150	150/150
Ø Flex	125	150	150
Ø Nom SW	125	125	150
SAP Code	168852	168853	168854

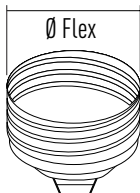

Nosecone				
Int Ø mm	125	150	180	200
SAP Code	168855	168856	168857	168858

Support Components

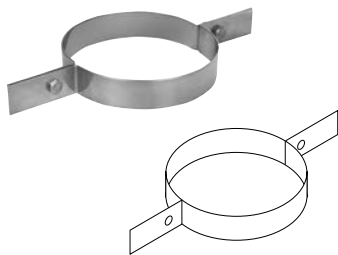

Top Clamp							
Int Ø mm	125	150	180	200	230	250	300
SAP Code	168717	168718	168719	168720	168721	168722	168723

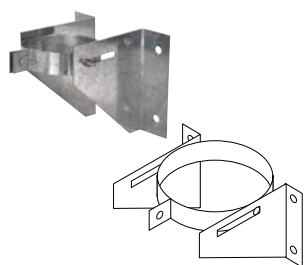

Bottom/Intermediate Support Bracket							
Int Ø mm	125	150	180	200	230	250	300
SAP Code	168738	168739	168740	168741	168742	168743	168744

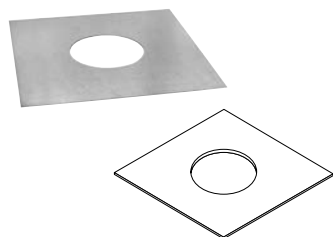

Top Plate							
Int Ø mm	125	150	180	200	230	250	300
SAP Code	168731	168732	168733	168734	168735	168736	168737
This item is used in conjunction with the Top Clamp to support the liner at the top of the stack. Can also be used as an intermediate support.							



Top Insert							
Int Ø mm	125	150	180	200	230	250	300
SAP Code	168724	168725	168726	168727	168728	168729	168730

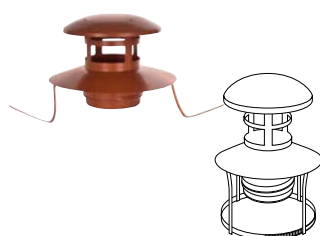

Combined Pot Hanger & Terminal					
Int Ø mm		125	150	180	200
SAP Code Terracotta		169096	169097	169098	169099
Sap Code Terracotta with Mesh		169100	169101	169102	169103
SAP Code Unpainted		168860	168861	160862	169863
SAP Code with Mesh		169016	169017	169018	169019

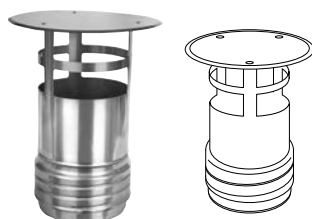

Terminal					
Int Ø mm		125	150	180	200
SAP Code		168864	168865	168866	168867

Other Ranges

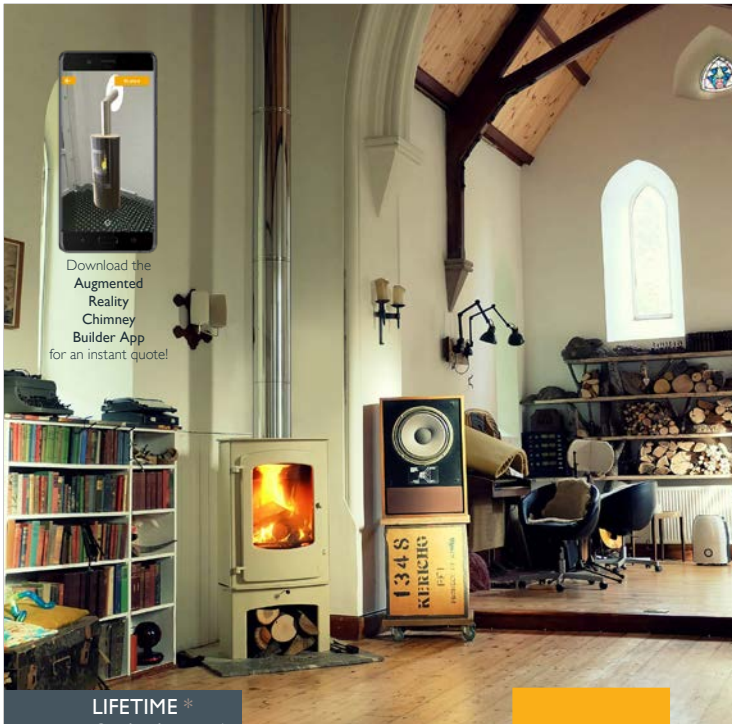

Download the
Augmented
Reality
Chimney
Builder App
for an instant quote!

LIFETIME *
GUARANTEE!

ICID Plus

100-150mm Diameter Range
Twin Wall Insulated System Chimney
for Gas, Oil, Wood and Multi-fuel



DON'T FORGET TO REGISTER YOUR INSTALLATIONS
AND START EARNING SCHIEDEL INSTALLER REWARDS
See inside for more details

www.schiedel.com/uk

SAP 940002164 - Updated 14 November 2023

SCHIEDEL



COMPLETE
SYSTEM

UK Plus Flue System

A modular, high quality stainless steel
concentric flue system for balanced
flue applications.

www.schiedel.com/uk

SAP 940003881 - December 2022

SCHIEDEL

SCHIEDEL

Schiedel Chimney Systems
Crowther Estate
Washington
Tyne & Wear NE38 0AQ
Tel. +44 (0)191 416 1150
Fax. +44 (0)191 415 1263

sales.uk@schiedel.com

SCHIEDEL INSTALLER REWARDS

Exciting news from Schiedel Chimney Systems!
Whenever you register an installation with our
easy to use, online guarantee registration portal,
you will now accrue points based on the number
of installations and installation type to redeem for
Love2Shop vouchers!



Follow us on Social Media @SchiedelUK



A standard
INDUSTRIES COMPANY